

TEM®

2026

Fiyat Listesi

İÇİNDEKİLER

- **Monofaze Prizler**
- 2** ● Monofaze Kauçuk Fiş & Prizler
- 3** ● Ray Tipi Priz ve Gösterge
- 4-5** ● Modüler Prizler
- 6** ● Blok Prizler
- 7** ● **Nemli Yer Kutusu**
- 8** ● **Bilgisayar IEC Soketleri**
- 9** ● **Telefon - Data Kapakları**
- 10** ● **Telefon - Data Konnektörler**
- 10** ● **Gerilim Koruma (SPD)**
- 11- 12** ● **Multimedya Soketler**
- 13** ● **Hızlı Şarj Cihazları**
- 14** ● **Kablosuz Şarj Cihazları**
- 14** ● **USB Şarj Adaptör**
- 15** ● **Akım Koruma**
- 15** ● **On - Off Anahtarlar**
- **Aluminyum Priz Grupları**
- 17** ● **WIFI Kontrollü Prizler**
- 18-19** ● **1U Prizler**
- 20** ● **1U GST PDU**
- 21** ● **U62 PDU**
- 22** ● **U52 PDU**
- 23-24** ● **U42 Prizler**
- 25-26** ● **Kolon Grupları**
- 27** ● **Masa Kapağı**
- 27** ● **Güç Çerçevesi PF 01**
- 28** ● **Güç Çerçevesi PF 02**
- 29** ● **Kapaklı Güç Çerçevesi FPF 03**
- 30** ● **Fırçalı Masa Grubu FPF 04**
- 31** ● **Bas - Aç Çerçevesi FPF 05 - U70**
- 32** ● **Fırçalı Bas-Aç Çerçevesi FPF 06-100**
- 33** ● **G70 Prizler**
- 34** ● **Gömülü Prizler**
- 34** ● **Pop-up Prizler**
- 35** ● **O44 Prizler**
- **Aydınlatma**
- 36-38** ● **1U Aydınlatma**
- 38** ● **U20 Aydınlatma**
- 39** ● **Lineer Aydınlatma**
- 40** ● **Prizli Aydınlatma**
- 41** ● **Yan Kapaklar**
- 42** ● **Dahili Priz Kutuları**
- 42** ● **Döşeme Altı Buat**
- 43** ● **Kauçuk - Trifaze Fiş & Prizler**
- 44-52** ● **Cee Norm Fiş & Prizler**
- 53** ● **Mbox**
- 54-59** ● **Kombinasyon Kutuları**
- 60** ● **Termoplastik Buatlar**
- 61-65** ● **Plastik Panolar**
- 66** ● **Taşıyıcı Ayak**
- 67-70** ● **Kablo Makaraları**
- 71** ● **Acil Aydınlatma**
- 72** ● **Diğer Ürünler**

Monofaze Prizler

16A

2P+E

200-250 V~

Tek Terminal Kapaksız



212.310.110.001.8
50x50 Şebeke
Pano Prizi
118,00 TL



252.310.120.001.9
Vidalı Şebeke Prizi
45°
95,00 TL



252.320.120.001.2
Vidalı UPS Prizi
45°
120,00 TL

Tek Terminal IP54



215.310.112.001.8
Şebeke Pano Prizi
126,00 TL



215.320.112.001.2
UPS Pano Prizi
140,00 TL

Çift Terminal IP54



215.310.212.001.6
Şebeke Pano Prizi
130,00 TL



215.320.212.001.2
UPS Pano Prizi
145,00 TL



440.116.160
IP44
Eğik Makine Prizi
160,00 TL



670.116.160
IP67 Kilitli Kapaklı
Eğik Makine Prizi
220,00 TL



440.116.150
IP44
Makine Prizi
160,00 TL



440.116.151
IP44 Dik Kasalı
Duvar Prizi
230,00 TL



440.116.152
IP44 Eğik Kasalı
Duvar Prizi
250,00 TL



440.116.153
IP44 Eğik Kasalı Duvar Prizi
+ Monofaze Pano Prizi
360,00 TL



Monofaze Kauçuk Fiş & Prizler

16A

2P+E

200-250 V~



215.116.200
Uzatma Prizi
160,00 TL



215.116.301
Düz Uzun Fiş
110,00 TL



215.116.300 | 215.316.300
Şebeke Düz Fiş UPS Düz Fiş
110,00 TL 125,00 TL



215.116.320 | 215.316.320
Şebeke Eğik Fiş UPS Eğik Fiş
135,00 TL 140,00 TL



215.116.101
Tekli Priz
230,00 TL



215.116.102
İkili Grup Priz
335,00 TL



215.116.103
Üçlü Grup Priz
350,00 TL



215.116.104
Dörtlü Grup Priz
440,00 TL



16A

2P+E

200-250 V~



Şebeke Prizi
Ledsiz
272.313.110.001.8
280,00 TL



Şebeke Prizi
Ledli
272.313.110.011.8
320,00 TL



UPS Prizi
Ledsiz
272.323.110.001.8
310,00 TL



UPS Prizi
Ledli
272.323.110.011.8
355,00 TL

Şebeke Gösterge Modülü



Monofaze Yeşil
272.1P10.Y
260,00 TL



Trifaze
272.3P10
350,00 TL

Şebeke - Topraklama Gösterge Modülü



Şebeke ve Topraklama Yeşil-Mavi
272.1PE10.YM
450,00 TL



Topraklama - Mavi
272.1PE10.M
400,00 TL

RCD Kestirici Modül



RCD Kestirici Modül
272.1R10.47X
240,00 TL

Tırnaklı Tek Terminalli Prizler

16A

2P+E

200-250 V~



252.311.120.001.9
Şebeke Prizi 45°
112,00 TL



252.321.120.001.2
UPS Prizi 45°
126,00 TL



252.311.110.001.9
Şebeke Prizi
112,00 TL



252.321.110.001.2
UPS Prizi
126,00 TL

Tırnaklı Çift Terminalli Prizler



252.311.220.001.9
Şebeke Prizi 45°
130,00 TL



252.321.220.001.2
UPS Prizi 45°
145,00 TL



252.311.210.001.9
Şebeke Prizi
130,00 TL



252.321.210.001.2
UPS Prizi
145,00 TL

Çift Tırnaklı Çift Terminalli Prizler



350.216.160
Kapaklı Şebeke Prizi
175,00 TL



350.316.160
Kapaklı UPS Prizi
195,00 TL



350.216.150
Şebeke Prizi 45°
140,00 TL



350.316.150
UPS Prizi 45°
155,00 TL

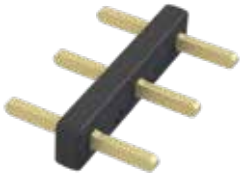

740.061.002
Priz Birleştirme
Aparatı
59,00 TL



253.611.101.2
45x45mm Universal Tip
265,00 TL



253.711.101.2
45x45mm Amerikan Tip
235,00 TL



253.811.101.2
45x45mm İngiliz Tip
205,00 TL



253.613.101.2
45x45mm İsrail Tip
350,00 TL



253.614.101.2
45x45mm İsvriçe Tip
375,00 TL



253.615.101.2
45x45mm G. Afrika Tip
375,00 TL



253.612.101.2
45x45mm Avrupa Multi Prizi
400,00 TL



253.411.101.2
51,5x45mm İngiliz
225,00 TL



721.130.300.2
İngiliz Fişi
250,00 TL



252.351.110.001.2
Tırnaklı Tek Terminalli
Fransız Prizi 45°
150,00 TL



252.351.120.001.2
Tırnaklı Tek Terminalli
Fransız Prizi
150,00 TL



ŞEBEKE TİP

16A 2P+E 200-250 V~

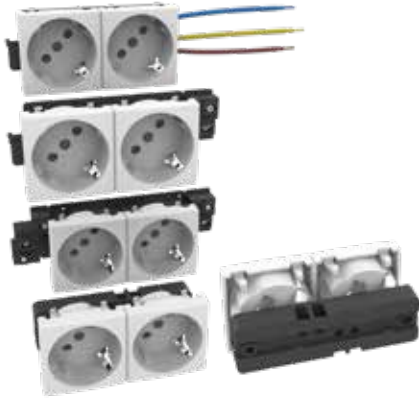

| | Açıklama | Ürün Kodu | B.Fiyat | Çocuk Emniyetli Kod | B.Fiyat |
|-------------------|-------------------|----------------|------------------|---------------------|------------------|
| Kablolu | 2'li Şebeke Prizi | 262.31.132.002 | 202,00 TL | 262.31.132.012 | 232,00 TL |
| | 3'lü Şebeke Prizi | 262.31.132.003 | 293,00 TL | 262.31.132.013 | 338,00 TL |
| Tek Yan Terminal | 2'li Şebeke Prizi | 262.31.112.002 | 249,00 TL | 262.31.112.012 | 279,00 TL |
| | 3'lü Şebeke Prizi | 262.31.112.003 | 340,00 TL | 262.31.112.013 | 385,00 TL |
| Çift Yan Terminal | 2'li Şebeke Prizi | 262.31.122.002 | 357,00 TL | 262.31.122.012 | 387,00 TL |
| | 3'lü Şebeke Prizi | 262.31.122.003 | 448,00 TL | 262.31.122.013 | 493,00 TL |
| Tek Alt Terminal | 2'li Şebeke Prizi | 262.31.142.002 | 224,00 TL | 262.31.142.012 | 254,00 TL |
| | 3'lü Şebeke Prizi | 262.31.142.003 | 308,00 TL | 262.31.142.013 | 353,00 TL |
| Çift Alt Terminal | 2'li Şebeke Prizi | 262.31.152.002 | 322,00 TL | 262.31.152.012 | 352,80 TL |
| | 3'lü Şebeke Prizi | 262.31.152.003 | 399,00 TL | 262.31.152.013 | 444,00 TL |

UPS TİP

16A 2P+E 200-250 V~



| | Açıklama | Ürün Kodu | B.Fiyat | Çocuk Emniyetli Kod | B.Fiyat |
|-------------------|----------------|----------------|------------------|---------------------|------------------|
| Kablolu | 2'li UPS Prizi | 262.32.132.002 | 235,00 TL | 262.32.132.012 | 265,00 TL |
| | 3'lü UPS Prizi | 262.32.132.003 | 336,00 TL | 262.32.132.013 | 381,00 TL |
| Tek Yan Terminal | 2'li UPS Prizi | 262.32.112.002 | 269,00 TL | 262.32.112.012 | 299,00 TL |
| | 3'lü UPS Prizi | 262.32.112.003 | 343,00 TL | 262.32.112.013 | 388,00 TL |
| Çift Yan Terminal | 2'li UPS Prizi | 262.32.122.002 | 386,00 TL | 262.32.122.012 | 416,00 TL |
| | 3'lü UPS Prizi | 262.32.122.003 | 458,00 TL | 262.32.122.013 | 503,00 TL |
| Tek Alt Terminal | 2'li UPS Prizi | 262.32.142.002 | 242,00 TL | 262.32.142.012 | 272,00 TL |
| | 3'lü UPS Prizi | 262.32.142.003 | 308,00 TL | 262.32.142.013 | 353,00 TL |
| Çift Alt Terminal | 2'li UPS Prizi | 262.32.152.002 | 350,00 TL | 262.32.152.012 | 380,00 TL |
| | 3'lü UPS Prizi | 262.32.152.003 | 413,00 TL | 262.32.152.013 | 458,00 TL |

FRANSIZ TİP

16A 2P+E 200-250 V~



| | Açıklama | Ürün Kodu | B.Fiyat |
|-------------------|--------------------|----------------|------------------|
| Kablolu | 2'li Fransız Prizi | 262.35.132.002 | 263,00 TL |
| | 3'lü Fransız Prizi | 262.35.132.003 | 377,00 TL |
| Tek Yan Terminal | 2'li Fransız Prizi | 262.35.112.002 | 330,00 TL |
| | 3'lü Fransız Prizi | 262.35.112.003 | 420,00 TL |
| Çift Yan Terminal | 2'li Fransız Prizi | 262.35.122.002 | 437,00 TL |
| | 3'lü Fransız Prizi | 262.35.122.003 | 538,00 TL |
| Tek Alt Terminal | 2'li Fransız Prizi | 262.35.142.002 | 297,00 TL |
| | 3'lü Fransız Prizi | 262.35.142.003 | 378,00 TL |
| Çift Alt Terminal | 2'li Fransız Prizi | 262.35.152.002 | 393,00 TL |
| | 3'lü Fransız Prizi | 262.35.152.003 | 484,00 TL |

BİLGİSAYAR IEC TİP 10A 2P+E 200-250 V~

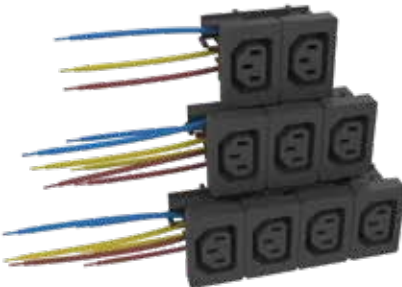

| Açıklama | Ürün Kodu | B.Fiyat |
|-----------------------|----------------|------------------|
| 2'li Bilgisayar Prizi | 262.33.131.002 | 235,00 TL |
| 3'lü Bilgisayar Prizi | 262.33.131.003 | 286,00 TL |
| 4'lü Bilgisayar Prizi | 262.33.131.004 | 364,00 TL |

İNGİLİZ TİP

13A 2P+E 200-250 V~



| | Açıklama | Ürün Kodu | B.Fiyat |
|----------------|--------------------|----------------|------------------|
| Kablolu | 2'li İngiliz Prizi | 262.38.131.002 | 302,00 TL |
| | 3'lü İngiliz Prizi | 262.38.131.003 | 353,00 TL |
| | 4'lü İngiliz Prizi | 262.38.131.004 | 470,00 TL |
| Çift Klemensli | 2'li İngiliz Prizi | 262.38.121.002 | 437,00 TL |
| | 3'lü İngiliz Prizi | 262.38.121.003 | 538,00 TL |
| | 4'lü İngiliz Prizi | 262.38.121.004 | 655,00 TL |

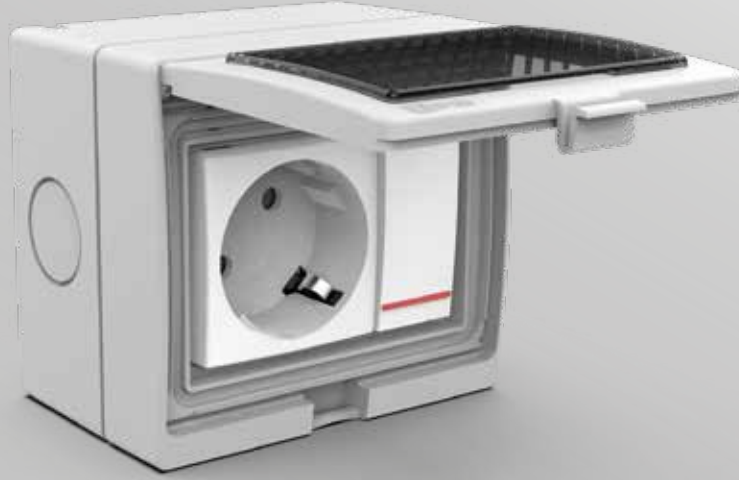

| Ürün Kodu | 2x22,5 Modül | Fiyat |
|-----------|------------------|------------------|
| 250.000 | 2 Modül Boş Kasa | 400,00 TL |
| 253.A12 | 2* Tekli Anahtar | 740,00 TL |
| 250.P11 | Şebeke Priz | 500,00 TL |
| 250.P21 | UPS Priz | 520,00 TL |
| 250.P51 | Fransız Priz | 530,00 TL |



| Ürün Kodu | 3x22,5 Modül | Fiyat |
|-----------|------------------------|------------------|
| 260.000 | 3 Modül Boş Kasa | 600,00 TL |
| 263.A1P1 | Anahtar + Şebeke Priz | 870,00 TL |
| 263.A1P21 | Anahtar + UPS Priz | 890,00 TL |
| 263.A1P51 | Anahtar + Fransız Priz | 900,00 TL |



| Ürün Kodu | 4x22,5 Modül | Fiyat |
|-----------|---------------------------|--------------------|
| 270.000 | 4 Modül Boş Kasa | 700,00 TL |
| 270.P12 | 2* Şebeke Priz | 900,00 TL |
| 270.P22 | 2* UPS Priz | 940,00 TL |
| 270.P52 | 2* Fransız Priz | 960,00 TL |
| 273.A2P11 | 2* Anahtar + Şebeke Priz | 1.140,00 TL |
| 273.A2P21 | 2* Anahtar + UPS Priz | 1.160,00 TL |
| 273.A2P51 | 2* Anahtar + Fransız Priz | 1.170,00 TL |



720.130.150
IEC C13 10A
Tırnaklı Gövde Priz
55,00 TL



720.130.160
IEC C13 10A
Vidalı Gövde Priz
55,00 TL



720.130.200
IEC C13 10A
Uzatma Prizi
90,00 TL



720.140.320
IEC C14 10A
Tırnaklı Gövde Fiş
55,00 TL



720.140.340
IEC C14 10A
Vidalı Gövde Fiş
70,00 TL



720.140.300
IEC C14 10A
Uzatma Fişi
90,00 TL



720.140.321
IEC C14 10A
45x45 Kapakta Fiş
62,00 TL



720.190.150
IEC C19 16A
Tırnaklı Gövde Priz
159,00 TL



720.190.160
IEC C19 16A
Vidalı Gövde Priz
159,00 TL



720.190.200
IEC C19 16A
Uzatma Prizi
499,00 TL



720.200.320
IEC C20 16A
Tırnaklı Gövde Fiş
189,00 TL



720.240.340
IEC C20 16A
Vidalı Gövde Fiş
189,00 TL



720.200.300
IEC C20 16A
Uzatma Fişi
499,00 TL



720.200.321
IEC C20 16A
45x45 Kapakta Fiş
258,00 TL



710.100.103
45x45mm Yaylı Kapaklı
45,00 TL



710.100.104
22,5x45mm Yaylı Kapaklı
30,00 TL



710.100.105
45x45mm Yaylı Kapaklı - Çiftli
60,00 TL



Kanal Üstü Telefon - Data Kapakları



710.100.106
45x45mm Kapaksız- Tekli
90,00 TL



710.100.107
45x45mm Kapaksız -
2x22,5 Çiftli
90,00 TL



710.100.111
22,5x45mm Kapaksız - Tekli
80,00 TL



709.100.103
45x45mm Patlatmalı
35,00 TL



709.100.104
22,5x45mm Patlatmalı
30,00 TL



45x45mm Kanal Üstü Keystone Kapakları



710.100.108
Yükseltme Kapağı
40,00 TL



710.100.109
Keystone - Faceplate - Tekli
70,00 TL



710.100.110
Keystone - Faceplate - Çiftli
78,00 TL



708.100.010
50x50mm - Tekli
30,00 TL



708.100.020
50x50mm - Çiftli
30,00 TL



Boşluk Kapakları



709.200.104
22x45mm
30,00 TL



709.200.103
45x45mm
35,00 TL



734.612.0120.0

900,00 TL

U_c : 255V - 50-60 Hz

U_{oc} : 5/10 kV

I_n : 2,5/5 kA

U_p : $\leq 1,5$ kV

Ölçü: 22,5x45x36mm



Not: Ürünün üzerindeki gösterge ışığı
Yeşil yanıyor ise, ürünün normal çalıştığı,
Kırmızı yanıyor ise, ürünün değiştirilmesi gerektiği
anlaşılmalıdır.

TEM Telefon ve Data Konnektörleri



715.100.030
CAT3 TELEFON
1,00 USD



715.100.050
CAT5E DATA
1,30 USD



715.100.060
CAT6 DATA
1,20 USD



715.100.060AMP
CAT6 DÖNER KİTLEME
2,30 USD



715.100.061AMP
CAT6A DATA
1,40 USD

Dişi - Dişi Telefon - Data Konnektörleri



715.200.030
CAT3 TELEFON
3,30 USD



715.200.050
CAT5E DATA
3,60 USD



715.200.060
CAT6 DATA
3,60 USD



715.200.061
CAT6A DATA
5,80 USD

Telefon Data Fişleri



710.100.350
CAT5 DATA Fişi
0,10 USD



710.100.360
CAT6 DATA Fişi
0,20 USD



710.100.332 - 2 PIN
TELEFON Fişi
0,08 USD



710.100.334 - 4 PIN
TELEFON Fişi
0,08 USD



710.100.336 - 6PIN
TELEFON Fişi
0,08 USD

Fiberoptik Keystone



715.800.001
SC-SC SM Simplex Fiber Optik
Keystone Kuplör
400,00 TL



715.800.002
LC Fiber Optik Keystone Kuplör
(Seramik Kılıflı ve Duplex)
400,00 TL



715.800.003
Fiber Optik Ağ Kuplörü
400,00 TL

45x45mm Tv Prizler



723.000.150
TV Prizi
350,00 TL



723.000.300
TV Prizi Erkek \varnothing 9.52mm
350,00 TL



723.000.400
TV Uydu Prizi
375,00 TL

VGA Konnektörleri



715.300.001
6+2 Klemens Girişli
22.5x45mm - Faceplate
400,00 TL



715.300.002
14+2 Klemens Girişli 22.5x45mm
Hızlı Montaj - Faceplate
500,00 TL



715.300.003
Soket Girişli
45x45mm - Faceplate
400,00 TL



715.300.004
Soket Girişli
22.5x45mm - Faceplate
250,00 TL



715.300.005
15 Klemens Girişli
22.5x45mm - Faceplate
400,00 TL



715.300.007
9 Pinli
22.5x45mm Faceplate
400,00 TL



715.300.009
B Soket Girişli
45x45mm - Faceplate
500,00 TL

RCA & STEREO Konnektörleri



715.500.002
RCA Konnektör 22.5x45mm
Klemensli - Faceplate
300,00 TL



715.500.001
RCA Konnektör 22.5x45mm
Klemensli - Faceplate
300,00 TL



715.600.001
Stereo Konnektör 22.5x45mm
Klemensli - Faceplate
170,00 TL

HDMI Konnektörleri



715.400.001
TİP A Dişi - Dişi 90°
22.5x45mm - Faceplate
400,00 TL



715.400.002
TİP A Dişi - Dişi 180°
22.5x45mm - Faceplate
400,00 TL



715.400.003
TİP A Dişi - Dişi Üstten
Giriş-Çıkışlı
22.5x45mm - Faceplate
400,00 TL

HDMI Konnektör



715.400.008
HDMI Konnektör TİP A Dişi-Dişi
45x45mm - Faceplate
800,00 TL

DISPLAY Konnektör



715.700.001
Display Port Konnektör Soket Girişli
45x45mm - Faceplate
800,00 TL

XLR Konnektör



715.600.002
XLR Dişi Soket
45x45mm Klemensli - Faceplate
400,00 TL

USB Konnektörleri



715.200.004
Standart A
USB AF/AF 90°
22.5x45mm - Faceplate
170,00 TL



715.200.005
Standart A
USB AF/AF 180°
22.5x45mm - Faceplate
170,00 TL



715.200.006
Standart A
Klemensli
22.5x45mm - Faceplate
170,00 TL

USB / HDMI Keystone



715.200.001
Standart B
Dişi - Dişi - Keystone
200,00 TL



715.200.002
Standart A
Dişi - Dişi - Keystone
200,00 TL



715.200.003
Standart A
Dişi - Dişi Kablolu - Keystone
570,00 TL



715.400.004
TİP A Dişi - Dişi
Keystone
300,00 TL



715.400.005
TİP A Dişi - Dişi
Kablolu Keystone
750,00 TL



645.001.030.A1C1B
30W - A/C
45x45x43mm
2.100,00 TL



622.000.020.A1C1B
20W - A/C
22,5x45x41mm
1.000,00 TL



622.101.010A1B
10,5W - A
22,5x45x45mm
800,00 TL



622.000.010.A1C1B
10,5W - A/C
22,5x45x41mm
900,00 TL



645.010.010A1C1B
10,5W A/C
45x45x37mm
1.450,00 TL



645.010.010.A2B
10,5W - A/A
45x45x37mm
1.450,00 TL



622.001.010.A1B
10,5W - A
45x45x37mm
800,00 TL



622.000.010.A2B
10,5W - A/A
45x45x37mm
800,00 TL



Masaüstü kablosuz Şarj



715.200.141
Giriş: 5V-2A -9V-2A
Çıkış: 15W/10W/7.5W/5W
İletim Mesafesi : Maks. 8mm
875,00 TL



715.200.151
Giriş: 5V 2A
USB Çıkış: 5V 1,5-2A
Kablosuz Şarj Çıkış : 5V 1A
Delik Çapı : 60mm
1.750,00 TL

Masa altı kablosuz Şarj

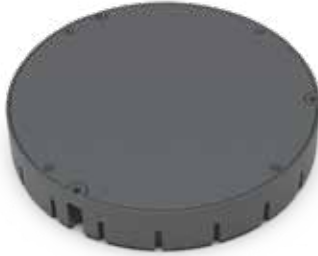

715.200.171
Giriş: 24V 1,5A
Kablosuz Şarj Çıkışı : 5W / 10W
İletim Mesafesi : 15mm - 30mm
7.000,00 TL

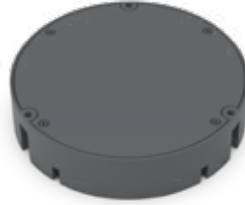

715.200.161
Giriş: 9V 2A
Kablosuz Şarj Çıkış : 5W / 10W
İletim Mesafesi : 14mm
4.350,00 TL

TEM USB Şarj Adaptör



620.000.020.A1C1B
20W - A/C
22,5x45x41mm
750,00 TL



620.000.030.A1C1B
30W - A/C
22,5x45x41mm
1.250,00 TL



620.000.065.A1C2B
65W - A/A/C
22,5x45x41mm
1.625,00 TL



Tip: C/C 1m

615.200.030.CC1B 30W **450,00 TL**
615.200.065.CC1B 65W **600,00 TL**
615.200.100.CC1B 100W **750,00 TL**

Teknik Özellikler

Akım Değeri : 16A
Voltaj Değeri : 125/250 V AC
Koruma Derecesi : IP40

723.225.016
160,00 TL



Reset Butonlu
22.5x45mm

723.225.116
160,00 TL



Reset Anahtarlı
22.5x45mm

TEM On-Off Anahtarlar



722.045.012
Tekli Anahtar 16A
45x45mm
Işsız
170,00 TL

722.045.112
Tekli Anahtar 16A
45x45mm
Işıklı
180,00 TL



722.045.011
Çiftli Anahtar
2x10A 45x45mm
Işsız
250,00 TL

722.045.111
Çiftli Anahtar
2x10A 45x45mm
Işıklı
260,00 TL



722.225.010
Anahtar 10A
22.5x45mm
Işsız
140,00 TL

722.225.110
Anahtar 10A
22.5x45mm
Işıklı
150,00 TL



722.225.021
Anahtar 16A
22.5x45mm
Işsız
170,00 TL



722.045.022
Çift Anahtar 2x16A
45x45mm
Işsız
240,00 TL



722.045.023
Anahtar 16A
45x45mm
220,00 TL



722.225.112
Anahtar 16A
22.5x45mm
Işıklı
190,00 TL



722.045.122
Çift Anahtar 2x16A
45x45mm
Işıklı
280,00 TL



722.045.122
Çift Anahtar 2x16A
22,5x45mm Zil
170,00 TL



722.225.112
Zil 16A
45x45mm
220,00 TL

TEM | Alüminyum Gövdeli Prizler

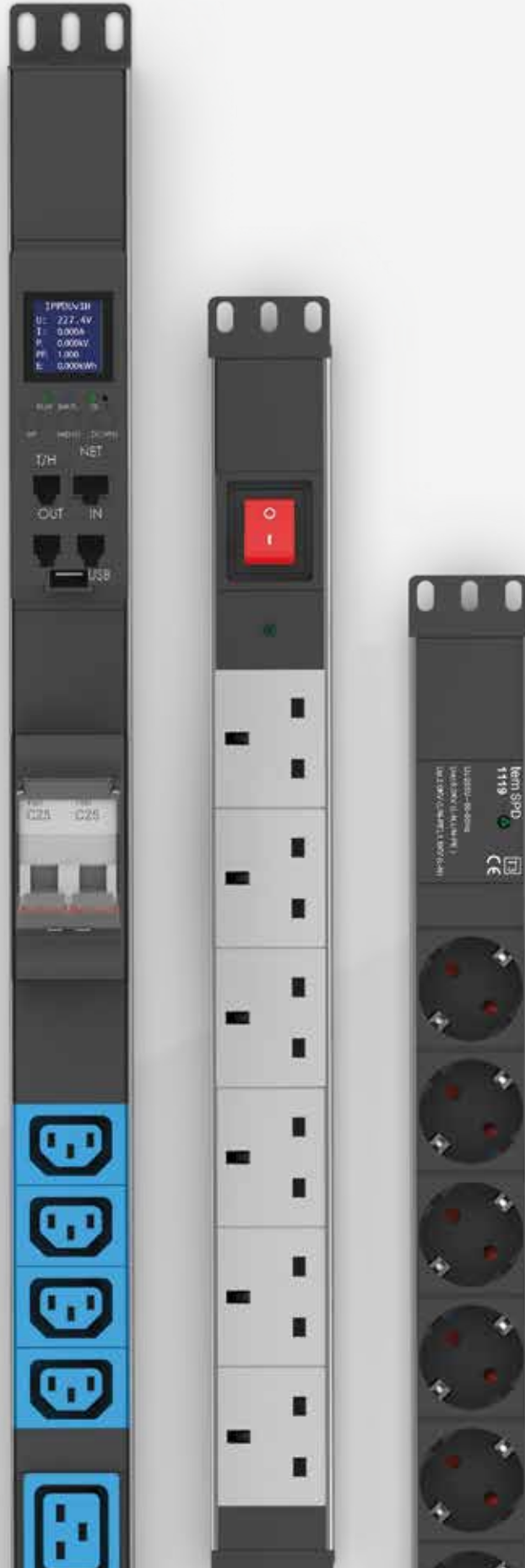

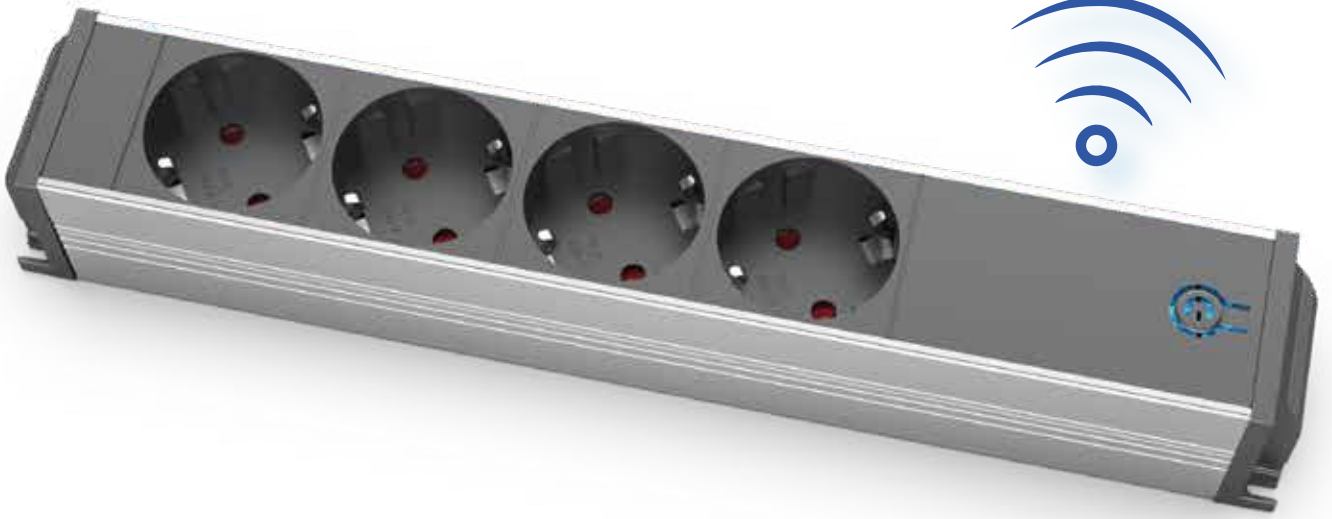

- Wifi & Bluetooth Bağlantısı
- Tuya ve Smartlife Uygulamaları ile bağlantı (IOS / Android)
- Güvenlik: Bebek-Çocuk Koruması
- Sesli Kontrol:
Amazon Alexa / Google Home
- Zamanlayıcı ayarlanabilir.
- Cihaz Paylaşımı
- Güç tüketimi (V, A, kW/h)



works with the
Google Assistant

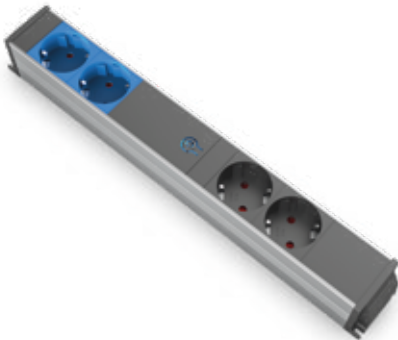

14017.1010.0202.1
4 Şebeke Prizli + 2'si
Wifi Kontrollü
2.700,00 TL



14017.1030.0202.1
3 Şebeke Prizi + USB Şarj
+ Wifi Kontrol
2.600,00 TL



14017.1040.0000.1
4 Şebeke Prizi +
Wifi Kontrol
2.650,00 TL



Standart



Ürün Kodu

- 14000.1070.000
- 14000.1080.000
- 19 14000.1090.000
- 14000.2070.000
- 14000.2080.000
- 19 14000.2090.000

Açıklama

- 7 Şebeke
- 8 Şebeke
- 9 Şebeke
- 7 UPS
- 8 UPS
- 9 UPS

Fiyat

- 1.120,00 TL
- 1.270,00 TL
- 1.425,00 TL
- 1.250,00 TL
- 1.420,00 TL
- 1.590,00 TL

Gerilim Korumalı



Ürün Kodu

- 14004.1060.000
- 19 14004.1070.000
- 14004.1080.000
- 14004.2060.000
- 19 14004.2070.000
- 14004.2080.000

Açıklama

- 6 Şebeke + Gerilim Koruma
- 7 Şebeke + Gerilim Koruma
- 8 Şebeke + Gerilim Koruma
- 6 UPS + Gerilim Koruma
- 7 UPS + Gerilim Koruma
- 8 UPS + Gerilim Koruma

Fiyat

- 1.800,00 TL
- 1.950,00 TL
- 2.100,00 TL
- 1.900,00 TL
- 2.050,00 TL
- 2.200,00 TL

Anahtarlı



Ürün Kodu

- 14003.1060.000
- 14003.1070.000
- 19 14003.1080.000
- 14003.2060.000
- 14003.2070.000
- 19 14003.2080.000

Açıklama

- 6 Şebeke + Anahtar
- 7 Şebeke + Anahtar
- 8 Şebeke + Anahtar
- 6 UPS + Anahtar
- 7 UPS + Anahtar
- 8 UPS + Anahtar

Fiyat

- 1.190,00 TL
- 1.340,00 TL
- 1.490,00 TL
- 1.300,00 TL
- 1.470,00 TL
- 1.640,00 TL

Tek Sigortalı



Ürün Kodu

- 14001.1040.000
- 19 14001.1060.000
- 14001.1080.000
- 14001.2040.000
- 19 14001.2060.000
- 14001.2080.000

Açıklama

- 4 Şebeke + Tekli Sigorta
- 6 Şebeke + Tekli Sigorta
- 8 Şebeke + Tekli Sigorta
- 4 UPS + Tekli Sigorta
- 6 UPS + Tekli Sigorta
- 8 UPS + Tekli Sigorta

Fiyat

- 1.400,00 TL
- 1.550,00 TL
- 1.700,00 TL
- 1.500,00 TL
- 1.700,00 TL
- 1.900,00 TL

Çift Sigortalı



Ürün Kodu

- 14002.1040.000
- 19 14002.1060.000
- 14002.1080.000
- 14002.2040.000
- 19 14002.2060.000
- 14002.2080.000

Açıklama

- 4 Şebeke + Çift Sigortalı
- 6 Şebeke + Çift Sigortalı
- 8 Şebeke + Çift Sigortalı
- 4 UPS + Çift Sigortalı
- 6 UPS + Çift Sigortalı
- 8 UPS + Çift Sigortalı

Fiyat

- 2.000,00 TL
- 2.300,00 TL
- 2.600,00 TL
- 2.080,00 TL
- 2.420,00 TL
- 2.760,00 TL

Butonlu Akım Korumalı



Ürün Kodu

- 14012.1060.000
- 14012.1070.000
- 19 14012.1080.000
- 14012.2060.000
- 14012.2070.000
- 19 14012.2080.000

Açıklama

- 6 Şebeke + Akım Koruma
- 7 Şebeke + Akım Koruma
- 8 Şebeke + Akım Koruma
- 6 UPS + Akım Koruma
- 7 UPS + Akım Koruma
- 8 UPS + Akım Koruma

Fiyat

- 1.357,00 TL
- 1.507,00 TL
- 1.660,00 TL
- 1.470,00 TL
- 1.640,00 TL
- 1.800,00 TL

Anahtarlı Akım Korumalı



Ürün Kodu

- 14013.1060.000
- 14013.1070.000
- 19 14013.1080.000
- 14013.2060.000
- 14013.2070.000
- 19 14013.2080.000

Açıklama

- 6 Şebeke + Anahtarlı Akım Koruma
- 7 Şebeke + Anahtarlı Akım Koruma
- 8 Şebeke + Anahtarlı Akım Koruma
- 6 UPS + Anahtarlı Akım Koruma
- 7 UPS + Anahtarlı Akım Koruma
- 8 UPS + Anahtarlı Akım Koruma

Fiyat

- 1.390,00 TL
- 1.540,00 TL
- 1.690,00 TL
- 1.500,00 TL
- 1.670,00 TL
- 1.840,00 TL

1U Kapak Modelleri

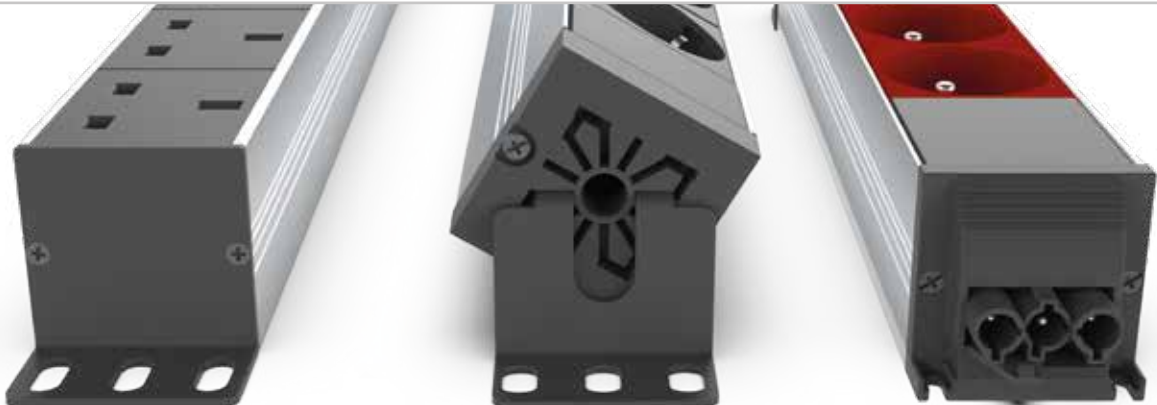



14002.0000.003
Çift Sigorta
2.040,00 TL



14014.0000.003
SPD + EMI-RFI Filtre
4.260,00 TL



14015.0000.003
SPD + Anahtar
1.720,00 TL



14000.1020.0202.3
2'li USB Şarj + 2 Şebeke
2.420,00 TL



14000.1040.003
4 Şebeke
1.470,00 TL



14003.1030.003
3 Şebeke + Anahtar
1.475,00 TL



725.3150.893
(Dişi + Erkek Soket)
3x1,5 H05VV-F 3m
900,00 TL



725.3150.913
3m Dişi Soket + UPS
3x1,5 H05VV-F 3m
800,00 TL



725.3150.933
3m Dişi Soket + C14
3x1,5 H05VV-F 3m
850,00 TL

**Boş Alüminyum Gövde****Ürün Kodu****Modül Sayısı
(22,5mm)****Fiyat**

| | | |
|----------------|-------------------|--------------------|
| 16200.0010.000 | 10 (2x22,5 Kapak) | 800,00 TL |
| 16200.0012.000 | 12 (2x22,5 Kapak) | 900,00 TL |
| 16200.0014.000 | 14 (2x22,5 Kapak) | 1.000,00 TL |
| 16200.0016.000 | 16 (2x22,5 Kapak) | 1.100,00 TL |
| 16200.0018.000 | 18 (2x22,5 Kapak) | 1.200,00 TL |
| 16200.0020.000 | 20 (2x22,5 Kapak) | 1.300,00 TL |

Örnek Ürünler

16200.1232.8711.0
3 Şebeke + 2 UPS + 1 Cat6 + 1 Cat3
1.960,00 TL



16200.1222.8722.0
2 Şebeke + 2 UPS + 2 Cat6 + 2 Cat3
2.180,00 TL



16200.1222.872111.0
2 Şebeke + 2 UPS + 1 Cat6 + 1 Cat 3
+ 2'li USB Şarj
3.060,00 TL



16200.1223.8721.0
2 Şebeke + 3 UPS + 2 Cat6 + 1 Cat3
2.200,00 TL



16200.1233.8711.0
3 Şebeke + 3 UPS + 1 Cat6 + 1 Cat3
2.280,00 TL



16200.1030.153111.0
3 Şebeke + 1 VGA + 1 HDMI + 1 USB Şarj
3.400,00 TL

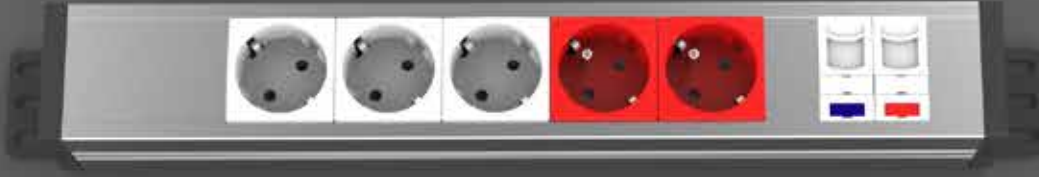

Boş Alüminyum Gövde



Ürün Kodu

Modül Sayısı (22,5mm)

Fiyat

15200.0010.000
15200.0012.000
15200.0014.000
15200.0016.000
15200.0018.000
15200.0020.000

10 (2x22,5 Kapak)
12 (2x22,5 Kapak)
14 (2x22,5 Kapak)
16 (2x22,5 Kapak)
18 (2x22,5 Kapak)
20 (2x22,5 Kapak)

700,00 TL
800,00 TL
900,00 TL
1.000,00 TL
1.100,00 TL
1.200,00 TL

Örnek Ürünler



15200.1232.8711.0
3 Şebeke + 2 UPS + 1 Cat6 + 1 Cat3
1,860,00 TL



15200.1222.8722.0
2 Şebeke + 2 UPS + 2 Cat6 + 2 Cat3
2,080,00 TL



15200.1222.872111.0
2 Şebeke + 2 UPS + 1 Cat6 + 1 Cat 3
+ 2'li USB Şarj
2,960,00 TL



15200.1223.8721.0
2 Şebeke + 3 UPS + 2 Cat6 + 1 Cat3
2,100,00 TL



15200.1233.8711.0
3 Şebeke + 3 UPS + 1 Cat6 + 1 Cat3
2,180,00 TL



15200.1030.153111.0
3 Şebeke + 1 VGA + 1 HDMI + 1 USB Şarj
3,300,00 TL



Standart



Ürün Kodu

- 14200.1070.000
- 19 14200.1080.000
- 14200.1090.000
- 14200.2070.000
- 19 14200.2080.000
- 14200.2090.000

Açıklama

- 7 Şebeke
- 8 Şebeke
- 9 Şebeke
- 7 UPS
- 8 UPS
- 9 UPS

Fiyat

- 1.880,00 TL**
- 2.034,00 TL**
- 2.188,00 TL**
- 1.972,00 TL**
- 2.157,00 TL**
- 2.341,00 TL**

Tek Sigortalı



Ürün Kodu

- 14201.1040.000
- 19 14201.1060.000
- 14201.1080.000
- 14201.2040.000
- 19 14201.2060.000
- 14201.2080.000

Açıklama

- 4 Şebeke + Tekli Sigorta
- 6 Şebeke + Tekli Sigorta
- 8 Şebeke + Tekli Sigorta
- 4 UPS + Tekli Sigorta
- 6 UPS + Tekli Sigorta
- 8 UPS + Tekli Sigorta

Fiyat

- 1.788,00 TL**
- 2.127,00 TL**
- 2.464,00 TL**
- 1.848,00 TL**
- 2.218,00 TL**
- 2.588,00 TL**

Anahtarlı



Ürün Kodu

- 14203.1060.000
- 19 14203.1070.000
- 14203.1080.000
- 14203.2060.000
- 19 14203.2070.000
- 14203.2080.000

Açıklama

- 6 Şebeke + Anahtar
- 7 Şebeke + Anahtar
- 8 Şebeke + Anahtar
- 6 UPS + Anahtar
- 7 UPS + Anahtar
- 8 UPS + Anahtar

Fiyat

- 1.664,00 TL**
- 1.848,00 TL**
- 2.034,00 TL**
- 1.757,00 TL**
- 1.957,00 TL**
- 2.157,00 TL**

TEM U42 PDU Örnek Ürünler



14200.1223.8721.0
2 Şebeke + 3 UPS + 2 Cat6 + 1 Cat3
2.311,00 TL



14200.1233.8711.0
3 Şebeke + 3 UPS + 1 Cat6 + 1 Cat3
2.173,00 TL



14200.1232.8711.0
3 Şebeke + 2 UPS + 1 Cat6 + 1 Cat3
1.972,00 TL



14200.1222.8722.0
2 Şebeke + 2 UPS + 2 Cat6 + 2 Cat3
2.327,00 TL



14202.1050.000
5 Şebeke + Çift Sigortalı
2.157,00 TL



14200.1040.110
4 Şebeke + 2'li USB Şarj
2.034,00 TL

TEM | W42 Örnek Ürünler



14300.1222.8722.0
2 Şebeke + 2 UPS + 2 Cat6 + 2 Cat3
2.557,00 TL



14300.1223.8721.0
2 Şebeke + 3 UPS + 2 Cat6 + 1 Cat3
2.588,00 TL



14300.1232.8711.0
3 Şebeke + 2 UPS + 1 Cat6 + 1 Cat3
2.327,00 TL

H100 Tavan Baęlantı Aparatı



H100 Kolon Ayaęı

Kolon Kanal Modelleri

U62

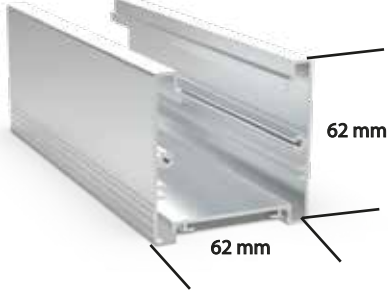

U62 Çiftli



H100

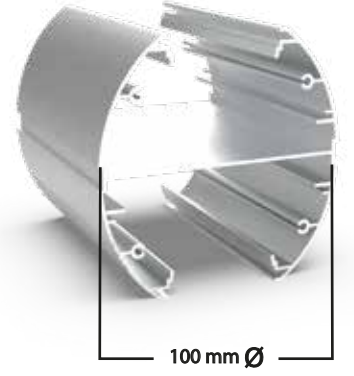

H100

11400.1244.8722.0
4 Şebeke + 4 UPS +
2 Cat6 + 2 Cat3
3.700,00 TL



H100

11400.1040.8142.0
4 Şebeke + 2x2'li USB Şarj
+ 4 Cat6
5.700,00 TL



H100

11400.1020.135222.0
2 Şebeke + 2 USB Şarj +
2 VGA + 2 HDMI
5.900,00 TL



H100

11400.1040.120
4 Şebeke
2x2'li USB Şarj
4.400,00 TL



U62 Çiftli

11000.1244.136222.0
4 Şebeke + 4 UPS + 2 USB Şarj
+ 2 HDMI + 2 RCA
6.700,00 TL

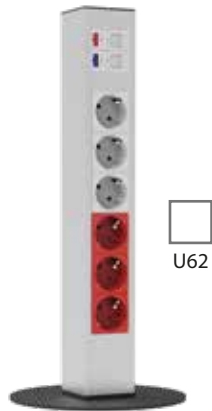

U62

1110.1233.8711.0
3 Şebeke + 3 UPS +
1 Cat 6 + 1 Cat 3
2.800,00 TL



U62

1110.1222.8200.0
2 Şebeke + 2 UPS
2 Cat6
2.600,00 TL



U62

1110.1040.3511.0
4 Şebeke + 1 HDMI
+ 1 VGA
3.200,00 TL



Boş Alüminyum Gövde

Ürün Kodu

Kesim Ölçüsü

a
(mm)

Fiyat

| | | | |
|----------------|---------|-----|--------------------|
| 17100.0010.000 | 232x105 | 225 | 940,00 TL |
| 17100.0012.000 | 277x105 | 270 | 1.000,00 TL |
| 17100.0014.000 | 322x105 | 315 | 1.100,00 TL |
| 17100.0016.000 | 367x105 | 360 | 1.200,00 TL |

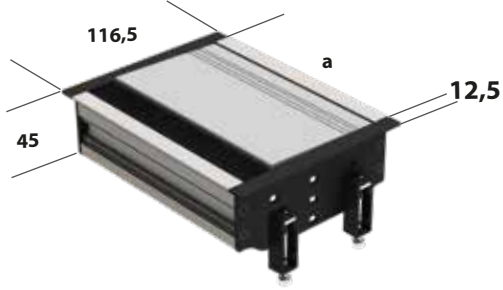

* a = Boş kanal içi kullanılabilirlik ölçüsü
a+25 = Toplam ürün ölçüsü

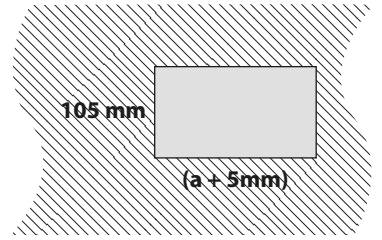

TEM Güç Çerçevesi PF 01



1750.1030.1211.1
3 Şebeke Prizi + Tip A/C USB Şarj
7.600,00 TL

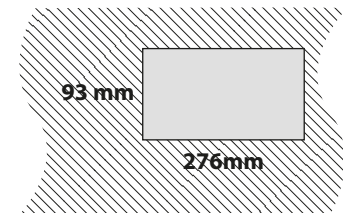

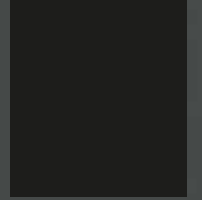

Boş Alüminyum Gövde

Ürün Kodu

Modül Sayısı
m (22,5)

Kesim Ölçüsü
a+7(mm)

a
(mm)

Fiyat

| | | | | |
|----------------|-------------------|----------|-----|--------------------|
| 17200.0010.000 | 10 (2x22,5 Kapak) | 232 x 55 | 225 | 800,00 TL |
| 17200.0012.000 | 12 (2x22,5 Kapak) | 277 x 55 | 270 | 900,00 TL |
| 17200.0014.000 | 14 (2x22,5 Kapak) | 322 x 55 | 315 | 1.000,00 TL |
| 17200.0016.000 | 16 (2x22,5 Kapak) | 367 x 55 | 360 | 1.100,00 TL |

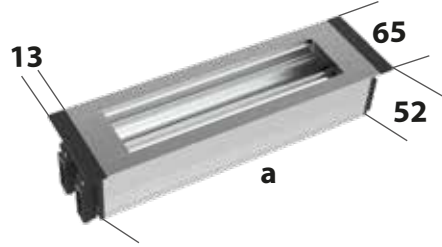

* a = Boş kanal içi kullanılabilirlik ölçüsü
a+26 = Toplam ürün ölçüsü

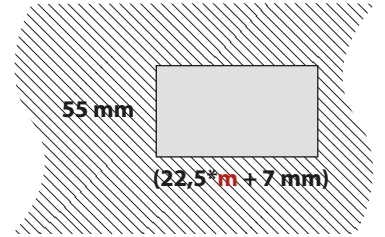

Ürün Kodu

Açıklama

Kesim Ölçüsü
a+6(mm)

a
(mm)

Fiyat

| | | | | |
|-------------------|---------------------------------------|------------|-------|--------------------|
| 17200.1020.110 | 2 Şebeke + USB Şarj | 208,5 x 55 | 202,5 | 2.000,00 TL |
| 17200.2030.8711.0 | 3 UPS + 1 Cat6 + 1 Cat3 | 276 x 55 | 270 | 2.080,00 TL |
| 17200.4020.1511.0 | 2 İngiliz Prizi + 1 USB Şarj + VGA | 243 x 55 | 225 | 1.800,00 TL |
| 17200.1222.820.0 | 2 Şebeke + 2 UPS + 2 Cat6 | 343,5 x 55 | 337,5 | 2.800,00 TL |





| Boş Alüminyum Gövde | Ürün Kodu | Modül Sayısı m (22,5) | Kesim Ölçüsü a+35(mm) | a (mm) | Fiyat |
|---------------------|--------------|--------------------------|--------------------------|-----------|--------------------|
| | 17300.0010.0 | 10 (2x22,5 Kapak) | 260x105 | 225 | 1.500,00 TL |
| | 17300.0012.0 | 12 (2x22,5 Kapak) | 305x105 | 270 | 1.700,00 TL |
| | 17300.0014.0 | 14 (2x22,5 Kapak) | 350x105 | 315 | 1.900,00 TL |
| | 17300.0016.0 | 16 (2x22,5 Kapak) | 395x105 | 360 | 2.100,00 TL |

* a = Boş kanal içi kullanılabilirlik ölçüsü
a+56 = Toplam ürün ölçüsü

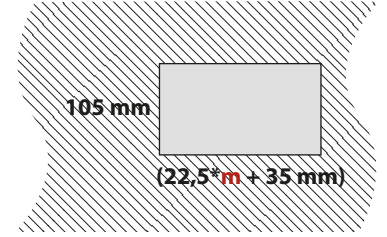

| Ürün Kodu | Açıklama | Kesim Ölçüsü a+35(mm) | a (mm) | Fiyat |
|-----------|----------|--------------------------|-----------|-------|
|-----------|----------|--------------------------|-----------|-------|

| | | | | | |
|--|-------------------|---|-------------|-------|--------------------|
| | 17300.1020.110 | 2 Şebeke + 1 USB Şarj | 237,5 x 105 | 202,5 | 2.800,00 TL |
| | 17300.1020.8711.0 | 2 Şebeke + 1 Cat6 + 1 Cat3 | 260 x 105 | 225 | 2.150,00 TL |
| | 17300.1222.8711.0 | 2 Şebeke + 2 UPS + 1 Cat6 + 1 Cat3 | 372,5 x 105 | 337,5 | 2.650,00 TL |
| | 17300.1631.210 | 3 Şebeke + 1 Üniversal Priz +2 adet A/C USB Şarj | 395 x 105 | 360 | 4.850,00 TL |



Boş Alüminyum Gövde

Ürün Kodu

Modül Sayısı

Kesim Ölçüsü

a
(mm)

Fiyat

17400.0010.000
17400.0012.000
17400.0014.000
17400.0016.000

m (22,5)
10 (2x22,5 Kapak)
12 (2x22,5 Kapak)
14 (2x22,5 Kapak)
16 (2x22,5 Kapak)

a+70(mm)
295 x 135
340 x 135
385 x 135
430 x 135

2.500,00 TL
2.700,00 TL
2.900,00 TL
3.100,00 TL

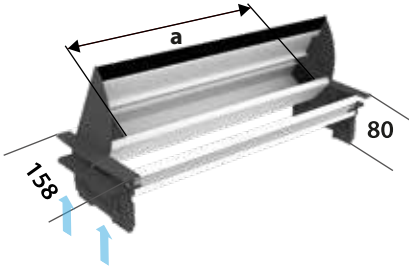

* a = Boş kanal içi kullanılabilirlik ölçüsü
a+70 = Ürün kesim ölçüsü
a+100 = Toplam ürün ölçüsü

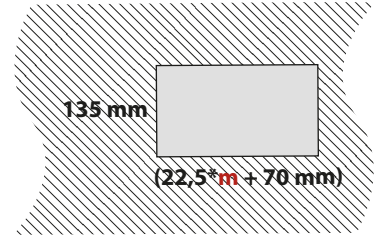

Ürün Kodu

Açıklama

Kesim Ölçüsü

a+70(mm)

a
(mm)

Fiyat

17400.1040.820

4 Şebeke + 2 Cat6

362,5x135

292,5

3.600,00 TL

17400.1222.8711.0

2 Şebeke + 2 UPS + 1 Cat6
+1 Cat3

385x135

315

3.650,00 TL

17400.1224.842

2 Şebeke + 4 UPS + 4 Cat6
+ Soket Girişli

520x135

450

4.650,00 TL

17400.1233.840

3 Şebeke + 3 UPS + 4 Cat6

520x135

450

4.700,00 TL





Boş Alüminyum Gövde

Ürün Kodu

Modül Sayısı

Kesim Ölçüsü

a
(mm)

Fiyat

| Boş Alüminyum Gövde | Ürün Kodu | Modül Sayısı m (22,5) | Kesim Ölçüsü a+25(mm) | a (mm) | Fiyat |
|---------------------|-----------|--------------------------|--------------------------|-----------|-------------|
| | 18077X10 | 10 (2x22,5 Kapak) | 250x105 | 225 | 1.000,00 TL |
| | 18077X12 | 12 (2x22,5 Kapak) | 295x105 | 270 | 1.100,00 TL |
| | 18077X14 | 14 (2x22,5 Kapak) | 340x105 | 315 | 1.200,00 TL |
| | 18077X16 | 16 (2x22,5 Kapak) | 385x105 | 360 | 1.300,00 TL |

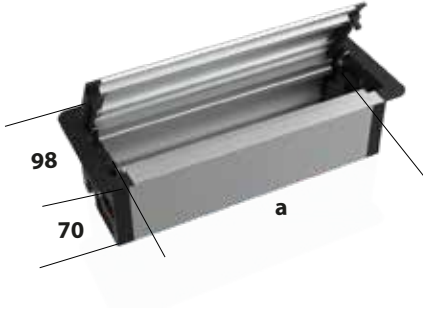

* a = Boş kanal içi kullanılabilirlik ölçüsü
a+49 = Toplam ürün ölçüsü

X : 1 Eloksal X : 3 Siyah X : 6 Beyaz

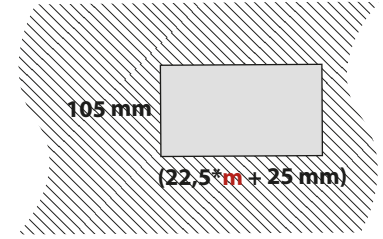

Ürün Kodu

Açıklama

Kesim Ölçüsü

a+25(mm)

a
(mm)

Fiyat

| Ürün Kodu | Açıklama | Kesim Ölçüsü a+25(mm) | a (mm) | Fiyat |
|--------------------|---|--------------------------|-----------|-------------|
| 18077XP12M11 | 2 Şebeke + 1 USB Şarj | 227,5 x 105 | 202,5 | 2.500,00 TL |
| 18077XP2M81M71 | 2 Şebeke + 1 Cat6 + 1 Cat3 | 250 x 105 | 225 | 1.650,00 TL |
| 18077XP12P22M81M71 | 2 Şebeke + 2 UPS + 1 Cat6 + 1 Cat3 | 340 x 105 | 315 | 2.050,00 TL |
| 18077XP23P61M12 | 3 Şebeke + 1 Üniversal Priz +2 adet A/C USB Şarj | 362,5 x 105 | 337,5 | 4.050,00 TL |



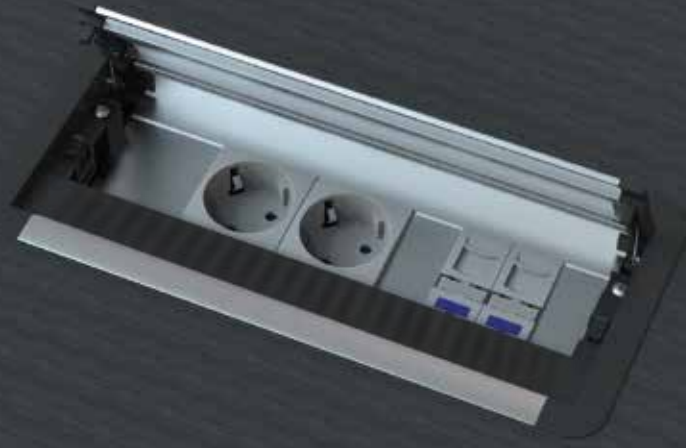

Boş Alüminyum Gövde

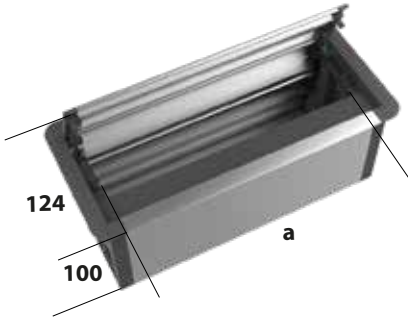

| Ürün Kodu | Modül Sayısı m (22,5) | Kesim Ölçüsü a+25(mm) | a (mm) | Fiyat |
|-----------|--------------------------|--------------------------|-----------|-------------|
| | | | | |
| 18011X10 | 10 (2x22,5 Kapak) | 250x105 | 225 | 1.100,00 TL |
| 18011X12 | 12 (2x22,5 Kapak) | 295x105 | 270 | 1.200,00 TL |
| 18011X14 | 14 (2x22,5 Kapak) | 340x105 | 315 | 1.300,00 TL |
| 18011X16 | 16 (2x22,5 Kapak) | 385x105 | 360 | 1.400,00 TL |

* a = Boş kanal içi kullanılabilirlik ölçüsü
a+49 = Toplam ürün ölçüsü

X : 1 Eloksal X : 3 Siyah X : 6 Beyaz

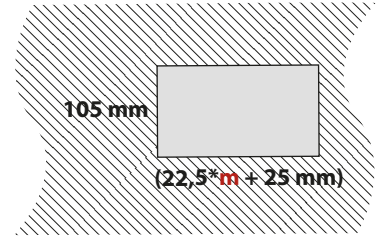

Ürün Kodu

Açıklama

Kesim Ölçüsü

a+25(mm)

a
(mm)

Fiyat

| | | | | |
|--------------------|---|-------------|-------|-------------|
| 18011XP12M11 | 2 Şebeke + 1 USB Şarj | 227,5 x 105 | 202,5 | 2.600,00 TL |
| 18011XP2M81M71 | 2 Şebeke + 1 Cat6 + 1 Cat3 | 250 x 105 | 225 | 1.750,00 TL |
| 18011XP12P22M81M71 | 2 Şebeke + 2 UPS + 1 Cat6 + 1 Cat3 | 340 x 105 | 315 | 2.150,00 TL |
| 18011XP23P61M12 | 3 Şebeke + 1 Üniversal Priz +2 adet A/C USB Şarj | 362,5 x 105 | 337,5 | 4.150,00 TL |





Boş Alüminyum Gövde

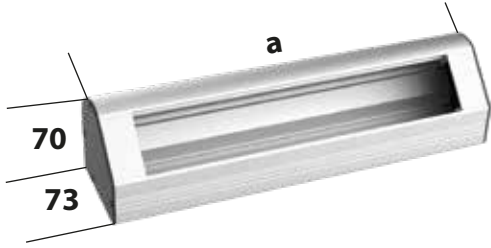

Ürün Kodu

Modül Sayısı (22,5mm)

Fiyat

| | | |
|----------------|-------------------|-------------|
| 17000.0010.000 | 10 (2x22,5 Kapak) | 1.000,00 TL |
| 17000.0012.000 | 12 (2x22,5 Kapak) | 1.100,00 TL |
| 17000.0014.000 | 14 (2x22,5 Kapak) | 1.200,00 TL |
| 17000.0016.000 | 16 (2x22,5 Kapak) | 1.300,00 TL |
| 17000.0018.000 | 18 (2x22,5 Kapak) | 1.400,00 TL |
| 17000.0020.000 | 20 (2x22,5 Kapak) | 1.500,00 TL |



17000.2030.8711.0
3 UPS + 1 Cat6 + 1 Cat3
1,850,00 TL



17000.2631.8711.0
3 UPS + 1 Üniversal Priz
+ 1 Cat6 + 1 Cat3
2,350,00 TL



17000.1222.8711.0
2 Şebeke + 2 UPS +
1 Cat6 + 1 Cat3
2,150,00 TL



17000.2030.187111.0
3 UPS + 1 Cat6 + 1 Cat3
+ 1 USB Şarj
2,500,00 TL

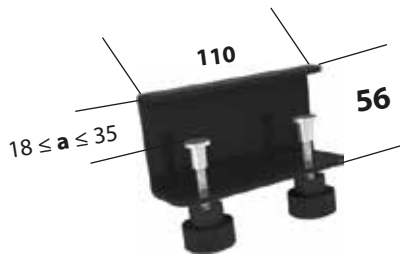

740.050.030
Küçük Boy (30mm)
650,00 TL

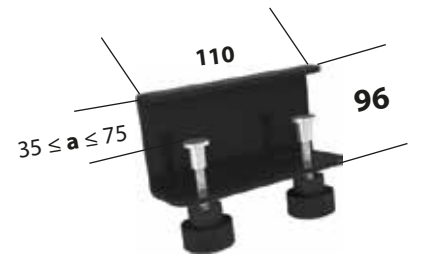

740.050.070
Büyük Boy (70mm)
950,00 TL

* a = Masa kalınlığı ölçüsü

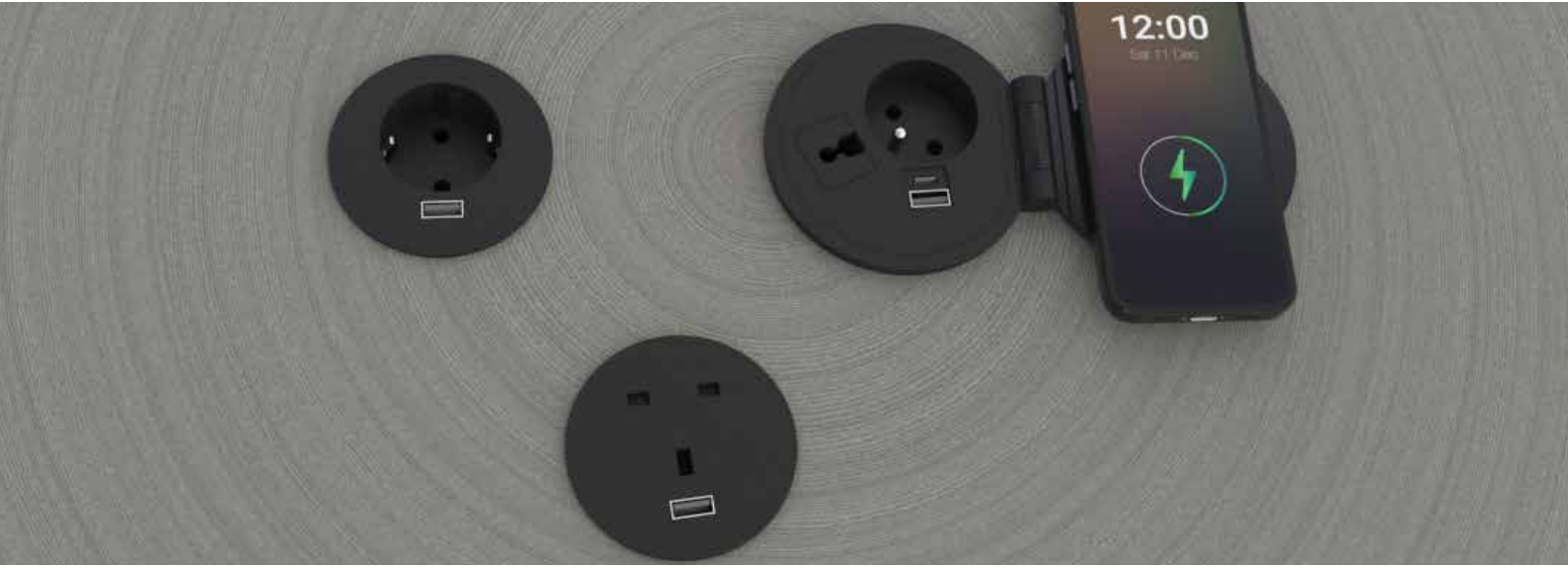

Priz + Tekli Şarj + USB Şarj

● Masa Kesim Ölçüsü: Ø60mm



1470.1010.1010.1
Şebeke Prizi + Tip A USB Şarj
3.050,00 TL



1470.5010.1010.1
Fransız Prizi + Tip A USB Şarj
3.240,00 TL



1470.4010.1010.1
İngiliz Prizi + Tip A USB Şarj
3.670,00 TL

Priz + A/C Şarj + Kablosuz Şarj Kapaklı

● Masa Kesim Ölçüsü: Ø80mm

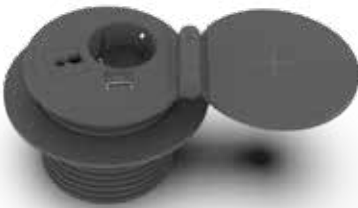

1460.1010.1211.1
Şebeke Prizi + 1Ad. Tip A/C USB Şarj
+ Kablosuz Şarj + Kablo Geçiş Yuvası
5.300,00 TL

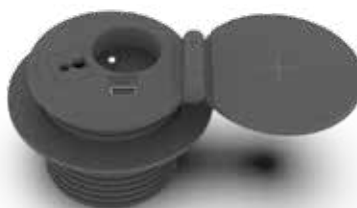

1460.5010.1211.1
Fransız Prizi + Tip A/C USB Şarj
+ Kablosuz Şarj + Kablo Geçiş Yuvası
5.500,00 TL

Pop-up

● Masa Kesim Ölçüsü: Ø120mm



1450.1040.1222.1
4lü Şebeke Prizi Kablosuz Şarj
+ 2 Ad. Tip A/C USB Şarj
Masa Kesim Ölçüsü :120mm
12.700,00 TL



1450.5040.1222.1
4lü Fransız Prizi + Kablosuz Şarj
+ 2 Ad. Tip A/C USB Şarj
Masa Kesim Ölçüsü :120mm
13.200,00 TL



| Ürün Kodu | Açıklama | a (mm) | Fiyat |
|----------------|---|-----------|--------------------|
| 11800.1020.210 | 2 Şebeke + 2'li USB Şarj | 232 | 3.050,00 TL |
| 11800.2020.210 | 2 UPS + 2'li USB Şarj | 232 | 3.100,00 TL |
| 11800.1030.000 | 3 Şebeke | 205 | 1.850,00 TL |
| 11800.2030.000 | 3 UPS | 205 | 1.900,00 TL |
| 11804.1020.210 | 2 Şebeke + 2'li USB Şarj + Gerilim Koruma | 307 | 3.700,00 TL |
| 11804.2020.210 | 2 UPS + 2'li USB Şarj + Gerilim Koruma | 307 | 3.750,00 TL |
| 11804.1030.000 | 3 Şebeke + Gerilim Koruma | 280 | 2.450,00 TL |
| 11804.2030.000 | 3 UPS + Gerilim Koruma | 280 | 2.500,00 TL |



Kesim Ölçüsü
(Ø)60mm

Masa Kalınlığı
0 - 50mm

- Kullanılmadıkça yer kaplamayan grup priz
- Özel kilit mekanizması



- PIR Hareket Sensörü
- IR Yaklaşım Kapı Sensörü
- IR Yaklaşım Aç Kapa
- Dokunmatik Aç Kapa
- Dokunmatik 3 Kademeli Dimmer
- On / Off Anahtar

- Giriş: 220 V Sürücülü
- 220 V Sürücüsüz
- 24 V Sürücüsüz

- Montaj: Askılı
- Vidalı
- Mıknatıslı

**Standart**

| | Ürün Kodu | Açıklama | Mıknatıssız Fiyat | Mıknatıslı Fiyat |
|-----------------------|------------------|----------------------|--------------------|--------------------|
| 220 V Sürücülü | 14005.20.3508.X1 | 35cm 8,4W 1m Kablolu | 2.025,00 TL | 2.625,00 TL |
| | 14005.20.5514.X1 | 55cm 14W 1m Kablolu | 2.350,00 TL | 2.950,00 TL |
| 24 V Sürücüsüz | 14005.40.3508.X1 | 35cm 8,4W 1m Kablolu | 1.280,00 TL | 1.875,00 TL |
| | 14005.40.5514.X1 | 55cm 14W 1m Kablolu | 1.600,00 TL | 2.200,00 TL |

X = 0 Mıknatıssız

X = 1 Mıknatıslı

On - Off Anahtarlı



| | Ürün Kodu | Açıklama | Mıknatıssız Fiyat | Mıknatıslı Fiyat |
|-----------------------|------------------|----------------------|--------------------|--------------------|
| 220 V Sürücülü | 14005.21.3508.X1 | 35cm 8,4W 1m Kablolu | 2.150,00 TL | 2.750,00 TL |
| | 14005.21.5514.X1 | 55cm 14W 1m Kablolu | 2.500,00 TL | 3.100,00 TL |
| 24 V Sürücüsüz | 14005.41.3508.X1 | 35cm 8,4W 1m Kablolu | 1.400,00 TL | 2.000,00 TL |
| | 14005.41.5514.X1 | 55cm 14W 1m Kablolu | 1.750,00 TL | 2.350,00 TL |
| | | X = 0 Mıknatıssız | | |
| | | X = 1 Mıknatıslı | | |

Dokunmatik Aç - Kapa



| | Ürün Kodu | Açıklama | Mıknatıssız Fiyat | Mıknatıslı Fiyat |
|-----------------------|------------------|----------------------|--------------------|--------------------|
| 220 V Sürücülü | 14005.22.3508.X1 | 35cm 8,4W 1m Kablolu | 2.700,00 TL | 3.300,00 TL |
| | 14005.22.5514.X1 | 55cm 14W 1m Kablolu | 3.050,00 TL | 3.600,00 TL |
| 24 V Sürücüsüz | 14005.42.3508.X1 | 35cm 8,4W 1m Kablolu | 1.950,00 TL | 2.550,00 TL |
| | 14005.42.5514.X1 | 55cm 14W 1m Kablolu | 2.250,00 TL | 2.850,00 TL |
| | | X = 0 Mıknatıssız | | |
| | | X = 1 Mıknatıslı | | |

PIR Hareket Sensörü



| | Ürün Kodu | Açıklama | Mıknatıssız Fiyat | Mıknatıslı Fiyat |
|-----------------------|------------------|----------------------|--------------------|--------------------|
| 220 V Sürücülü | 14005.23.3508.X1 | 35cm 8,4W 1m Kablolu | 3.600,00 TL | 4.200,00 TL |
| | 14005.23.5514.X1 | 55cm 14W 1m Kablolu | 3.950,00 TL | 4.500,00 TL |
| 24 V Sürücüsüz | 14005.43.3508.X1 | 35cm 8,4W 1m Kablolu | 2.900,00 TL | 3.500,00 TL |
| | 14005.43.5514.X1 | 55cm 14W 1m Kablolu | 3.200,00 TL | 3.800,00 TL |
| | | X = 0 Mıknatıssız | | |
| | | X = 1 Mıknatıslı | | |

Yaklaşım Kapı Sensörü



**220 V
Sürücülü**

Ürün Kodu Açıklama
14005.24.3508.X1 35cm 8,4W 1m Kablolu
14005.24.5514.X1 55cm 14W 1m Kablolu

Mıknatıssız Fiyat

Mıknatıslı Fiyat

3.550,00 TL
3.3900,00 TL

4.150,00 TL
4.500,00 TL

**24 V
Sürücüsüz**

14005.44.3508.X1 35cm 8,4W 1m Kablolu
14005.44.5514.X1 55cm 14W 1m Kablolu

3.000,00 TL
3.150,00 TL

3.400,00 TL
3.750,00 TL

X = 0 Mıknatıssız
X = 1 Mıknatıslı

3 Kademeli Dimmer



**220 V
Sürücülü**

Ürün Kodu Açıklama
14005.25.3508.X1 35cm 8,4W 1m Kablolu
14005.25.5514.X1 55cm 14W 1m Kablolu

Mıknatıssız Fiyat

Mıknatıslı Fiyat

2.700,00 TL
3.000,00 TL

3.300,00 TL
3.600,00 TL

**24 V
Sürücüsüz**

14005.45.3508.X1 35cm 8,4W 1m Kablolu
14005.45.5514.X1 55cm 14W 1m Kablolu

1.950,00 TL
2.250,00 TL

2.550,00 TL
2.850,00 TL

X = 0 Mıknatıssız
X = 1 Mıknatıslı

IR Yaklaşım Aç - Kapa



**220 V
Sürücülü**

Ürün Kodu Açıklama
14005.26.3508.X1 35cm 8,4W 1m Kablolu
14005.26.5514.X1 55cm 14W 1m Kablolu

Mıknatıssız Fiyat

Mıknatıslı Fiyat

3.550,00 TL
3.900,00 TL

4.150,00 TL
4.500,00 TL

**24 V
Sürücüsüz**

14005.46.3508.X1 35cm 8,4W 1m Kablolu
14005.46.5514.X1 55cm 14W 1m Kablolu

2.800,00 TL
3.150,00 TL

3.400,00 TL
3.750,00 TL

X = 0 Mıknatıssız
X = 1 Mıknatıslı

U20 Aydınlatma



220 V

Ürün Kodu Açıklama
1200.27.3505.X1 220V 1m Kablolu + 35cm 5W
1200.27.4106.X1 220V 1m Kablolu + 41cm 6W
1200.27.5210.X1 220V 1m Kablolu + 52cm 10W
1200.28.2004.X1 24V 1m Kablolu + 20cm 4.3W
1200.28.3004.X1 24V 1m Kablolu + 30cm 4.3W
1200.29.5007.X1 24V 1m Kablolu + 50cm 7.2W
1200.29.10014.X1 24V 1m Kablolu + 100cm 14.1W

Mıknatıssız Fiyat

Mıknatıslı Fiyat

1.700,00 TL
1.850,00 TL
2.100,00 TL
1.800,00 TL
2.400,00 TL
2.600,00 TL
4.300,00 TL

1.800,00 TL
1.900,00 TL
2.200,00 TL
1.900,00 TL
2.500,00 TL
2.800,00 TL
4.600,00 TL

X = 0 Mıknatıssız
X = 1 Mıknatıslı



- Giriş: 220 V Sürüclü
24 V Sürücüsüz

- Montaj: Askılı
Vidalı
Mıknatıslı

Tip 1U

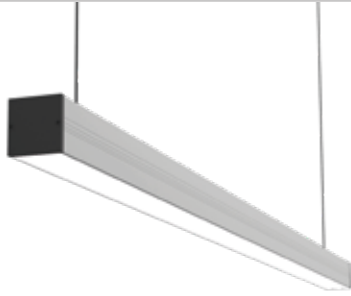

| | Ürün Kodu | Açıklama | Fiyat |
|----------------------|-----------------|-------------|--------------------|
| 220 V Sürüclü | 140025.20.6016 | 60cm 16,8W | 3.000,00 TL |
| | 140025.20.9025 | 90cm 25,2W | 3.700,00 TL |
| | 140025.20.12033 | 120cm 33,6W | 4.500,00 TL |
| | 140025.20.15042 | 150cm 42W | 5.200,00 TL |
| 24 V | 140025.40.6016 | 60cm 16,8W | 2.200,00 TL |
| | 140025.40.9025 | 90cm 25,2W | 3.000,00 TL |
| | 140025.40.12033 | 120cm 33,6W | 3.700,00 TL |
| | 140025.40.15042 | 150cm 42W | 4.500,00 TL |

Tip C

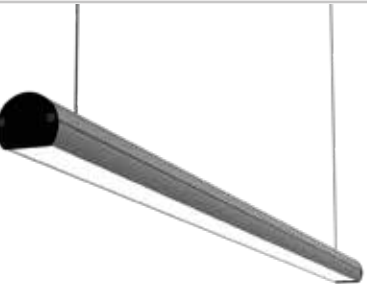

| | Ürün Kodu | Açıklama | Fiyat |
|----------------------|-----------------|-------------|--------------------|
| 220 V Sürüclü | 140425.20.6016 | 60cm 16,8W | 3.050,00 TL |
| | 140425.20.9025 | 90cm 25,2W | 3.800,00 TL |
| | 140425.20.12033 | 120cm 33,6W | 4.600,00 TL |
| | 140425.20.15042 | 150cm 42W | 5.400,00 TL |
| 24 V | 140425.40.6016 | 60cm 16,8W | 2.300,00 TL |
| | 140425.40.9025 | 90cm 25,2W | 3.100,00 TL |
| | 140425.40.12033 | 120cm 33,6W | 3.900,00 TL |
| | 140425.40.15042 | 150cm 42W | 4.700,00 TL |



- Giriş: 220 V Sürücülü
24 V Sürücüsüz

- Montaj: Vidalı
Mıknatıslı

Tip 1U



220 V Sürücülü

Ürün Kodu

Açıklama

Mıknatıssız Fiyat

Mıknatıslı Fiyat

14005.1013.1020.X0

2 Şebeke + 13cm LED

1.700,00 TL

2.500,00 TL

14005.1013.2020.X0

2 UPS + 13cm LED

1.750,00 TL

2.300,00 TL

220 V Sürücülü

14005.2030.1020.X0

2 Şebeke + 30cm LED

2.600,00 TL

3.150,00 TL

14005.2030.2020.X0

2 UPS + 30cm LED

2.700,00 TL

3.200,00 TL

X = 0 Mıknatıssız

X = 1 Mıknatıslı

Tip G70



220 V Sürücülü

Ürün Kodu

Açıklama

Fiyat

17005.2030.1020.0

2 Şebeke + 30cm LED

2.850,00 TL

17005.2030.1040.0

4 Şebeke + 30cm LED

3.150,00 TL

17005.2050.1020.0

2 Şebeke + 50cm LED

3.600,00 TL

17005.2050.1040.0

4 Şebeke + 50cm LED

3.900,00 TL

1U Yan Kapaklar



Düz L Yan Kapak



Dönerli Yan Kapak



Soketli Yan Kapak



Kulaksız Yan Kapak



Ayarlanabilir Kısa Yan Kapak



Ayarlanabilir Uzun Yan Kapak

U42 Yan Kapaklar



Vidalı yan kapak



Geçmeli Bağlantılı Yan Kapak



Düz L Yan Kapak



Plastik Yan Kapak

U52 Yan Kapaklar

U62 Yan Kapaklar



45° Eğik Masa Kulağ

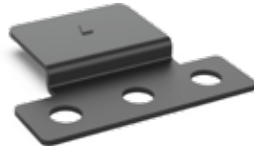

Metal Kulak



Plastik Kulaksız Yan Kapak



Plastik L Yan Kapak



Kabinet Dikey Montaj aparatı



Kabinet Yatay Montaj aparatı

TEM Dahili Priz Kutuları



210.0000.0000
113x210x70mm
400,00 TL



210.1200.4400
4 Şebeke + 4 UPS
1.600,00 TL



212.1000.6000
6 Şebeke + 2'li Sigorta Yeri
1.100,00 TL



280.0000.0000
210x280x70mm
700,00 TL



280.1200.6600
6 Şebeke + 6 UPS
2.300,00 TL



282.1200.6300
6 Şebeke + 3 UPS + 2'li Sigorta Yeri
1.900,00 TL

TEM Döşeme Altı Buat



207.120.003
3x22,5 Pop-Up Döşeme Altı Buat
2.300,00 TL



207.140.004
4x22,5 Pop-Up Döşeme Altı Buat
3.400,00 TL



207.230.006
6x22,5 Pop-Up Döşeme Altı Buat
4.500,00 TL

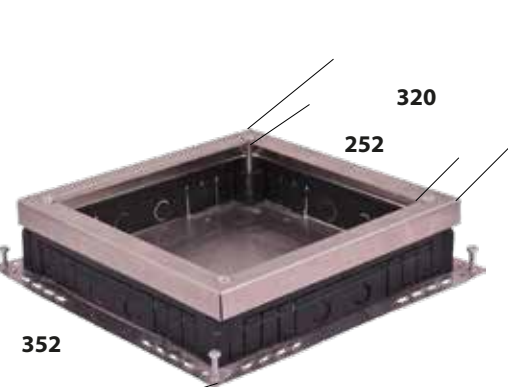

205.310.000
Döşeme Altı Buat
1.500,00 TL

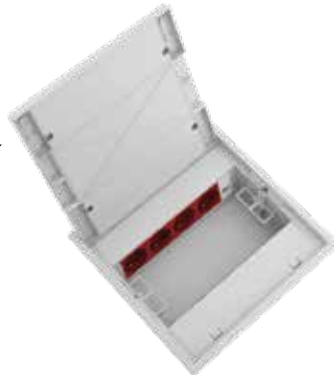

206.252.018
18 Adet 22.5 Modül
1.300,00 TL

Trifaze Fiş & Prizler 4x25 A

25A

380-415 V~



Trifaze Prizler 3x16 A

16A

IP54

380-415 V~



Trifaze Prizler 3x32 A

32A

IP54

380-415 V~



Dik Pano Prizleri

IP54 50/60 Hz.



| Ürün Kodu | Kutup | I(A) | h | Volt |  | Fiyat |
|-------------|--------|------|---|---------|---|-----------|
| 444.316.280 | 2P+E | 16 | 4 | 110-130 | 12 | 432,00 TL |
| 446.316.280 | 2P+E | 16 | 6 | 200-250 | 12 | 350,00 TL |
| 446.332.280 | 2P+E | 32 | 6 | 200-250 | 12 | 500,00 TL |
| 446.416.280 | 3P+E | 16 | 6 | 380-415 | 12 | 420,00 TL |
| 446.432.280 | 3P+E | 32 | 6 | 380-415 | 12 | 580,00 TL |
| 446.516.280 | 3P+N+E | 16 | 6 | 380-415 | 12 | 500,00 TL |
| 446.532.280 | 3P+N+E | 32 | 6 | 380-415 | 12 | 675,00 TL |

Eğik Pano Prizleri

IP54 50/60 Hz.



| Ürün Kodu | Kutup | I(A) | h | Volt |  | Fiyat |
|-------------|--------|------|---|---------|---|-------------|
| 444.316.250 | 2P+E | 16 | 4 | 110-130 | 12 | 432,00 TL |
| 446.316.250 | 2P+E | 16 | 6 | 200-250 | 12 | 350,00 TL |
| 446.332.250 | 2P+E | 32 | 6 | 200-250 | 12 | 500,00 TL |
| 446.416.250 | 3P+E | 16 | 6 | 380-415 | 12 | 420,00 TL |
| 446.432.250 | 3P+E | 32 | 6 | 380-415 | 12 | 580,00 TL |
| 446.463.250 | 3P+E | 63 | 6 | 380-415 | 6 | 1.650,00 TL |
| 446.516.250 | 3P+N+E | 16 | 6 | 380-415 | 12 | 500,00 TL |
| 446.532.250 | 3P+N+E | 32 | 6 | 380-415 | 12 | 675,00 TL |
| 446.563.250 | 3P+N+E | 63 | 6 | 380-415 | 6 | 2.100,00 TL |

Uzatma Prizleri

IP54 50/60 Hz.



| Ürün Kodu | Kutup | I(A) | h | Volt |  | Fiyat |
|-------------|--------|------|---|---------|---|-------------|
| 444.316.200 | 2P+E | 16 | 4 | 110-130 | 12 | 460,00 TL |
| 446.316.200 | 2P+E | 16 | 6 | 200-250 | 12 | 375,00 TL |
| 446.332.200 | 2P+E | 32 | 6 | 200-250 | 12 | 540,00 TL |
| 446.416.200 | 3P+E | 16 | 6 | 380-415 | 12 | 445,00 TL |
| 446.432.200 | 3P+E | 32 | 6 | 380-415 | 12 | 620,00 TL |
| 446.463.200 | 3P+E | 63 | 6 | 380-415 | 6 | 2.436,00 TL |
| 446.516.200 | 3P+N+E | 16 | 6 | 380-415 | 12 | 525,00 TL |
| 446.532.200 | 3P+N+E | 32 | 6 | 380-415 | 12 | 650,00 TL |
| 446.563.200 | 3P+N+E | 63 | 6 | 380-415 | 6 | 2.784,00 TL |

Uzatma Fişleri

IP54 50/60 Hz.



| Ürün Kodu | Kutup | I(A) | h | Volt |  | Fiyat |
|-------------|--------|------|---|---------|---|-------------|
| 444.316.300 | 2P+E | 16 | 4 | 110-130 | 12 | 325,00 TL |
| 446.316.300 | 2P+E | 16 | 6 | 200-250 | 12 | 275,00 TL |
| 446.332.300 | 2P+E | 32 | 6 | 200-250 | 12 | 445,00 TL |
| 446.416.300 | 3P+E | 16 | 6 | 380-415 | 12 | 325,00 TL |
| 446.432.300 | 3P+E | 32 | 6 | 380-415 | 12 | 475,00 TL |
| 446.463.300 | 3P+E | 63 | 6 | 380-415 | 6 | 1.653,00 TL |
| 446.516.300 | 3P+N+E | 16 | 6 | 380-415 | 12 | 405,00 TL |
| 446.532.300 | 3P+N+E | 32 | 6 | 380-415 | 12 | 525,00 TL |
| 446.563.300 | 3P+N+E | 63 | 6 | 380-415 | 6 | 2.001,00 TL |

Dik Pano Prizleri

IP67 50/60 Hz.



| Ürün Kodu | Kutup | I(A) | h | Volt |  | Fiyat |
|-------------|--------|------|---|---------|---|-----------|
| 674.316.280 | 2P+E | 16 | 4 | 110-130 | 12 | 540,00 TL |
| 676.316.280 | 2P+E | 16 | 6 | 200-250 | 12 | 470,00 TL |
| 676.332.280 | 2P+E | 32 | 6 | 200-250 | 12 | 740,00 TL |
| 676.416.280 | 3P+E | 16 | 6 | 380-415 | 12 | 640,00 TL |
| 676.432.280 | 3P+E | 32 | 6 | 380-415 | 12 | 800,00 TL |
| 676.516.280 | 3P+N+E | 16 | 6 | 380-415 | 12 | 700,00 TL |
| 676.532.280 | 3P+N+E | 32 | 6 | 380-415 | 12 | 875,00 TL |

Eğik Pano Prizleri

IP67 50/60 Hz.



| Ürün Kodu | Kutup | I(A) | h | Volt |  | Fiyat |
|-------------|--------|------|---|---------|---|-------------|
| 674.316.250 | 2P+E | 16 | 4 | 110-130 | 12 | 540,00 TL |
| 676.316.250 | 2P+E | 16 | 6 | 200-250 | 12 | 470,00 TL |
| 676.332.250 | 2P+E | 32 | 6 | 200-250 | 12 | 740,00 TL |
| 676.416.250 | 3P+E | 16 | 6 | 380-415 | 12 | 640,00 TL |
| 676.432.250 | 3P+E | 32 | 6 | 380-415 | 12 | 800,00 TL |
| 676.463.250 | 3P+E | 63 | 6 | 380-415 | 6 | 1.950,00 TL |
| 676.516.250 | 3P+N+E | 16 | 6 | 380-415 | 12 | 700,00 TL |
| 676.532.250 | 3P+N+E | 32 | 6 | 380-415 | 12 | 875,00 TL |
| 676.563.250 | 3P+N+E | 63 | 6 | 380-415 | 6 | 2.450,00 TL |

Uzatma Prizleri

IP67 50/60 Hz.



| Ürün Kodu | Kutup | I(A) | h | Volt |  | Fiyat |
|-------------|--------|------|---|---------|---|-------------|
| 674.316.200 | 2P+E | 16 | 4 | 110-130 | 12 | 685,00 TL |
| 676.316.200 | 2P+E | 16 | 6 | 200-250 | 12 | 600,00 TL |
| 676.332.200 | 2P+E | 32 | 6 | 200-250 | 12 | 770,00 TL |
| 676.416.200 | 3P+E | 16 | 6 | 380-415 | 12 | 670,00 TL |
| 676.432.200 | 3P+E | 32 | 6 | 380-415 | 12 | 830,00 TL |
| 676.463.200 | 3P+E | 63 | 6 | 380-415 | 6 | 2.450,00 TL |
| 676.516.200 | 3P+N+E | 16 | 6 | 380-415 | 12 | 750,00 TL |
| 676.532.200 | 3P+N+E | 32 | 6 | 380-415 | 12 | 850,00 TL |
| 676.563.200 | 3P+N+E | 63 | 6 | 380-415 | 6 | 2.900,00 TL |

Uzatma Fişleri

IP67 50/60 Hz.



| Ürün Kodu | Kutup | I(A) | h | Volt |  | Fiyat |
|-------------|--------|------|---|---------|---|-------------|
| 674.316.300 | 2P+E | 16 | 4 | 110-130 | 12 | 475,00 TL |
| 676.316.300 | 2P+E | 16 | 6 | 200-250 | 12 | 455,00 TL |
| 676.332.300 | 2P+E | 32 | 6 | 200-250 | 12 | 640,00 TL |
| 676.416.300 | 3P+E | 16 | 6 | 380-415 | 12 | 480,00 TL |
| 676.432.300 | 3P+E | 32 | 6 | 380-415 | 12 | 690,00 TL |
| 676.463.300 | 3P+E | 63 | 6 | 380-415 | 6 | 1.700,00 TL |
| 676.516.300 | 3P+N+E | 16 | 6 | 380-415 | 12 | 580,00 TL |
| 676.532.300 | 3P+N+E | 32 | 6 | 380-415 | 12 | 740,00 TL |
| 676.563.300 | 3P+N+E | 63 | 6 | 380-415 | 6 | 2.100,00 TL |

Eğik Duvar Prizleri

IP54 50/60 Hz.



| Ürün Kodu | Kutup | I(A) | h | Volt |  | Fiyat |
|-------------|--------|------|---|---------|---|-----------|
| 444.316.282 | 2P+E | 16 | 4 | 110-130 | 10 | 712,00 TL |
| 446.316.282 | 2P+E | 16 | 6 | 200-250 | 10 | 630,00 TL |
| 446.332.282 | 2P+E | 32 | 6 | 200-250 | 6 | 820,00 TL |
| 446.416.282 | 3P+E | 16 | 6 | 380-415 | 10 | 700,00 TL |
| 446.432.282 | 3P+E | 32 | 6 | 380-415 | 6 | 900,00 TL |
| 446.516.282 | 3P+N+E | 16 | 6 | 380-415 | 10 | 780,00 TL |
| 446.532.282 | 3P+N+E | 32 | 6 | 380-415 | 6 | 945,00 TL |

Eğik Duvar Prizleri + Monofaze

IP54 50/60 Hz.



| Ürün Kodu | Kutup | I(A) | h | Volt |  | Fiyat |
|-------------|--------|------|---|---------|---|-------------|
| 444.316.283 | 2P+E | 16 | 4 | 110-130 | 10 | 847,00 TL |
| 446.316.283 | 2P+E | 16 | 6 | 200-250 | 10 | 765,00 TL |
| 446.332.283 | 2P+E | 32 | 6 | 200-250 | 6 | 955,00 TL |
| 446.416.283 | 3P+E | 16 | 6 | 380-415 | 10 | 835,00 TL |
| 446.432.283 | 3P+E | 32 | 6 | 380-415 | 6 | 1.035,00 TL |
| 446.516.283 | 3P+N+E | 16 | 6 | 380-415 | 10 | 915,00 TL |
| 446.532.283 | 3P+N+E | 32 | 6 | 380-415 | 6 | 1.080,00 TL |

Dik Duvar Prizleri

IP54 50/60 Hz.



| Ürün Kodu | Kutup | I(A) | h | Volt |  | Fiyat |
|-------------|--------|------|---|---------|---|-----------|
| 444.316.281 | 2P+E | 16 | 4 | 110-130 | 10 | 665,00 TL |
| 446.316.281 | 2P+E | 16 | 6 | 200-250 | 10 | 580,00 TL |
| 446.332.281 | 2P+E | 32 | 6 | 200-250 | 6 | 770,00 TL |
| 446.416.281 | 3P+E | 16 | 6 | 380-415 | 10 | 650,00 TL |
| 446.432.281 | 3P+E | 32 | 6 | 380-415 | 6 | 850,00 TL |
| 446.516.281 | 3P+N+E | 16 | 6 | 380-415 | 6 | 730,00 TL |
| 446.532.281 | 3P+N+E | 32 | 6 | 380-415 | 6 | 895,00 TL |



444.316.282



444.316.281



444.316.200

Eğik Duvar Prizleri

IP67 50/60 Hz.



| Ürün Kodu | Kutup | I(A) | h | Volt |  | Fiyat |
|-------------|--------|------|---|---------|---|-------------|
| 674.316.282 | 2P+E | 16 | 4 | 110-130 | 10 | 930,00 TL |
| 676.316.282 | 2P+E | 16 | 6 | 200-250 | 10 | 850,00 TL |
| 676.332.282 | 2P+E | 32 | 6 | 200-250 | 6 | 1.020,00 TL |
| 676.416.282 | 3P+E | 16 | 6 | 380-415 | 10 | 920,00 TL |
| 676.432.282 | 3P+E | 32 | 6 | 380-415 | 6 | 1.100,00 TL |
| 676.516.282 | 3P+N+E | 16 | 6 | 380-415 | 10 | 1.000,00 TL |
| 676.532.282 | 3P+N+E | 32 | 6 | 380-415 | 6 | 1.145,00 TL |

Eğik Duvar Prizleri + Monofaze

IP54 50/60 Hz.



| Ürün Kodu | Kutup | I(A) | h | Volt |  | Fiyat |
|-------------|--------|------|---|---------|---|-------------|
| 674.316.283 | 2P+E | 16 | 4 | 110-130 | 10 | 1.065,00 TL |
| 676.316.283 | 2P+E | 16 | 6 | 200-250 | 10 | 985,00 TL |
| 676.332.283 | 2P+E | 32 | 6 | 200-250 | 6 | 1.155,00 TL |
| 676.416.283 | 3P+E | 16 | 6 | 380-415 | 10 | 1.055,00 TL |
| 676.432.283 | 3P+E | 32 | 6 | 380-415 | 6 | 1.235,00 TL |
| 676.516.283 | 3P+N+E | 16 | 6 | 380-415 | 10 | 1.135,00 TL |
| 676.532.283 | 3P+N+E | 32 | 6 | 380-415 | 6 | 1.280,00 TL |

Dik Duvar Prizleri

IP67 50/60 Hz.



| Ürün Kodu | Kutup | I(A) | h | Volt |  | Fiyat |
|-------------|--------|------|---|---------|---|-------------|
| 674.316.281 | 2P+E | 16 | 4 | 110-130 | 10 | 880,00 TL |
| 676.316.281 | 2P+E | 16 | 6 | 200-250 | 10 | 800,00 TL |
| 676.332.281 | 2P+E | 32 | 6 | 200-250 | 6 | 970,00 TL |
| 676.416.281 | 3P+E | 16 | 6 | 380-415 | 10 | 870,00 TL |
| 676.432.281 | 3P+E | 32 | 6 | 380-415 | 6 | 1.050,00 TL |
| 676.516.281 | 3P+N+E | 16 | 6 | 380-415 | 10 | 950,00 TL |
| 676.532.281 | 3P+N+E | 32 | 6 | 380-415 | 6 | 1.095,00 TL |

Pano Fişleri

IP54 50/60 Hz.



| Ürün Kodu | Kutup | I(A) | h | Volt |  | Fiyat |
|-------------|--------|------|---|---------|---|-----------|
| 444.316.380 | 2P+E | 16 | 4 | 110-130 | 12 | 400,00 TL |
| 446.316.380 | 2P+E | 16 | 6 | 200-250 | 12 | 350,00 TL |
| 446.332.380 | 2P+E | 32 | 6 | 200-250 | 12 | 520,00 TL |
| 446.416.380 | 3P+E | 16 | 6 | 380-415 | 12 | 400,00 TL |
| 446.432.380 | 3P+E | 32 | 6 | 380-415 | 12 | 570,00 TL |
| 446.516.380 | 3P+N+E | 16 | 6 | 380-415 | 12 | 500,00 TL |
| 446.532.380 | 3P+N+E | 32 | 6 | 380-415 | 12 | 620,00 TL |

Dik Kasalı Duvar Fişleri

IP54 50/60 Hz.



| Ürün Kodu | Kutup | I(A) | h | Volt |  | Fiyat |
|-------------|--------|------|---|---------|---|-----------|
| 444.316.381 | 2P+E | 16 | 4 | 110-130 | 10 | 515,00 TL |
| 446.316.381 | 2P+E | 16 | 6 | 200-250 | 10 | 470,00 TL |
| 446.332.381 | 2P+E | 32 | 6 | 200-250 | 5 | 670,00 TL |
| 446.416.381 | 3P+E | 16 | 6 | 380-415 | 10 | 500,00 TL |
| 446.432.381 | 3P+E | 32 | 6 | 380-415 | 5 | 720,00 TL |
| 446.516.381 | 3P+N+E | 16 | 6 | 380-415 | 10 | 620,00 TL |
| 446.532.381 | 3P+N+E | 32 | 6 | 380-415 | 6 | 770,00 TL |

Eğik Duvar Fişleri

IP54 50/60 Hz.



| Ürün Kodu | Kutup | I(A) | h | Volt |  | Fiyat |
|-------------|--------|------|---|---------|---|-----------|
| 444.316.382 | 2P+E | 16 | 4 | 110-130 | 10 | 590,00 TL |
| 446.316.382 | 2P+E | 16 | 6 | 200-250 | 10 | 540,00 TL |
| 446.332.382 | 2P+E | 32 | 6 | 200-250 | 6 | 770,00 TL |
| 446.416.382 | 3P+E | 16 | 6 | 380-415 | 10 | 570,00 TL |
| 446.432.382 | 3P+E | 32 | 6 | 380-415 | 6 | 820,00 TL |
| 446.516.382 | 3P+N+E | 16 | 6 | 380-415 | 10 | 700,00 TL |
| 446.532.382 | 3P+N+E | 32 | 6 | 380-415 | 6 | 870,00 TL |

Eğik Duvar Fişleri + Monofaze

IP54 50/60 Hz.



| Ürün Kodu | Kutup | I(A) | h | Volt |  | Fiyat |
|-------------|--------|------|---|---------|---|-------------|
| 444.316.383 | 2P+E | 16 | 4 | 110-130 | 10 | 725,00 TL |
| 446.316.383 | 2P+E | 16 | 6 | 200-250 | 10 | 675,00 TL |
| 446.332.383 | 2P+E | 32 | 6 | 200-250 | 6 | 905,00 TL |
| 446.416.383 | 3P+E | 16 | 6 | 380-415 | 10 | 705,00 TL |
| 446.432.383 | 3P+E | 32 | 6 | 380-415 | 6 | 955,00 TL |
| 446.516.383 | 3P+N+E | 16 | 6 | 380-415 | 10 | 835,00 TL |
| 446.532.383 | 3P+N+E | 32 | 6 | 380-415 | 6 | 1.005,00 TL |

Uzatma 3'lü Çoklayıcı Prizler (Fiş Girişli)

IP44

6h

50/60 Hz.



| Ürün Kodu | Kutup | I(A) | Volt |  | Fiyat |
|----------------|------------|------|---------|---|--------------------|
| 1344.316.333.0 | 3 (2P+E) | 16 | 200-250 | 2 | 3.735,00 TL |
| 1344.332.333.0 | 3 (2P+E) | 32 | 200-250 | 4 | 7.550,00 TL |
| 1344.416.333.0 | 4 (3P+E) | 16 | 380-415 | 2 | 4.850,00 TL |
| 1344.432.333.0 | 4 (3P+E) | 32 | 380-415 | 2 | 8.300,00 TL |
| 1344.516.333.0 | 5 (3P+N+E) | 16 | 380-415 | 2 | 5.490,00 TL |
| 1344.532.333.0 | 5 (3P+N+E) | 32 | 380-415 | 2 | 8.770,00 TL |

Uzatma 3'lü Çoklayıcı Prizler (Fiş Girişli)

IP67

6h

50/60 Hz.



| Ürün Kodu | Kutup | I(A) | Volt |  | Fiyat |
|----------------|------------|------|---------|---|--------------------|
| 1367.316.333.0 | 3 (2P+E) | 16 | 200-250 | 2 | 5.230,00 TL |
| 1367.332.333.0 | 3 (2P+E) | 32 | 200-250 | 4 | 8.290,00 TL |
| 1367.416.333.0 | 4 (3P+E) | 16 | 380-415 | 2 | 6.340,00 TL |
| 1367.432.333.0 | 4 (3P+E) | 32 | 380-415 | 2 | 8.915,00 TL |
| 1367.516.333.0 | 5 (3P+N+E) | 16 | 380-415 | 2 | 7.310,00 TL |
| 1367.532.333.0 | 5 (3P+N+E) | 32 | 380-415 | 2 | 9.315,00 TL |

Uzatma 3'lü Çoklayıcı Prizler (Rekor Girişli)

IP44

6h

50/60 Hz.



| Ürün Kodu | Kutup | I(A) | Volt |  | Fiyat |
|----------------|------------|------|---------|---|--------------------|
| 1344.316.333.1 | 3 (2P+E) | 16 | 200-250 | 2 | 3.600,00 TL |
| 1344.332.333.1 | 3 (2P+E) | 32 | 200-250 | 4 | 5.500,00 TL |
| 1344.416.333.1 | 4 (3P+E) | 16 | 380-415 | 2 | 4.000,00 TL |
| 1344.432.333.1 | 4 (3P+E) | 32 | 380-415 | 2 | 5.700,00 TL |
| 1344.516.333.1 | 5 (3P+N+E) | 16 | 380-415 | 4 | 4.700,00 TL |
| 1344.532.333.1 | 5 (3P+N+E) | 32 | 380-415 | 4 | 6.300,00 TL |

Uzatma 3'lü Çoklayıcı Prizler (Rekor Girişli)

IP67

6h

50/60 Hz.



| Ürün Kodu | Kutup | I(A) | Volt |  | Fiyat |
|----------------|------------|------|---------|---|--------------------|
| 1367.316.333.1 | 3 (2P+E) | 16 | 200-250 | 2 | 4.150,00 TL |
| 1367.332.333.1 | 3 (2P+E) | 32 | 200-250 | 4 | 6.300,00 TL |
| 1367.416.333.1 | 4 (3P+E) | 16 | 380-415 | 2 | 4.550,00 TL |
| 1367.432.333.1 | 4 (3P+E) | 32 | 380-415 | 2 | 6.500,00 TL |
| 1367.516.333.1 | 5 (3P+N+E) | 16 | 380-415 | 4 | 5.300,00 TL |
| 1367.532.333.1 | 5 (3P+N+E) | 32 | 380-415 | 4 | 7.100,00 TL |

İçten Kilitli Şalterli Pano Prizi (Yatay Tip)

IP44

6h

50/60 Hz.



| Ürün Kodu | Kutup | I(A) | Volt |  | Fiyat |
|-------------|------------|------|---------|---|-------------|
| 1444.316.15 | 3 (2P+E) | 16 | 200-250 | 1 | 3.400,00 TL |
| 1444.332.15 | 3 (2P+E) | 32 | 200-250 | 1 | 4.000,00 TL |
| 1444.416.15 | 4 (3P+E) | 16 | 380-415 | 1 | 3.950,00 TL |
| 1444.432.15 | 4 (3P+E) | 32 | 380-415 | 1 | 4.700,00 TL |
| 1444.516.15 | 5 (3P+N+E) | 16 | 380-415 | 1 | 4.350,00 TL |
| 1444.532.15 | 5 (3P+N+E) | 32 | 380-415 | 1 | 5.300,00 TL |

İçten Kilitli Şalterli Pano Prizi (Yatay Tip)

IP67

6h

50/60 Hz.



| Ürün Kodu | Kutup | I(A) | Volt |  | Fiyat |
|-------------|------------|------|---------|---|-------------|
| 1467.316.15 | 3 (2P+E) | 16 | 200-250 | 1 | 4.000,00 TL |
| 1467.332.15 | 3 (2P+E) | 32 | 200-250 | 1 | 4.850,00 TL |
| 1467.416.15 | 4 (3P+E) | 16 | 380-415 | 1 | 4.400,00 TL |
| 1467.432.15 | 4 (3P+E) | 32 | 380-415 | 1 | 5.250,00 TL |
| 1467.516.15 | 5 (3P+N+E) | 16 | 380-415 | 1 | 4.850,00 TL |
| 1467.532.15 | 5 (3P+N+E) | 32 | 380-415 | 1 | 5.700,00 TL |

İçten Kilitli Şalterli Duvar Prizi (Yatay Tip)

IP44

6h

50/60 Hz.



| Ürün Kodu | Kutup | I(A) | Volt |  | Fiyat |
|-------------|------------|------|---------|---|-------------|
| 1444.316.10 | 3 (2P+E) | 16 | 200-250 | 1 | 3.800,00 TL |
| 1444.332.10 | 3 (2P+E) | 32 | 200-250 | 1 | 4.450,00 TL |
| 1444.416.10 | 4 (3P+E) | 16 | 380-415 | 1 | 4.200,00 TL |
| 1444.432.10 | 4 (3P+E) | 32 | 380-415 | 1 | 5.050,00 TL |
| 1444.516.10 | 5 (3P+N+E) | 16 | 380-415 | 1 | 4.600,00 TL |
| 1444.532.10 | 5 (3P+N+E) | 32 | 380-415 | 1 | 5.450,00 TL |

İçten Kilitli Şalterli Duvar Prizi (Yatay Tip)

IP67

6h

50/60 Hz.



| Ürün Kodu | Kutup | I(A) | Volt |  | Fiyat |
|-------------|------------|------|---------|---|-------------|
| 1467.316.10 | 3 (2P+E) | 16 | 200-250 | 1 | 4.400,00 TL |
| 1467.332.10 | 3 (2P+E) | 32 | 200-250 | 1 | 5.250,00 TL |
| 1467.416.10 | 4 (3P+E) | 16 | 380-415 | 1 | 4.800,00 TL |
| 1467.432.10 | 4 (3P+E) | 32 | 380-415 | 1 | 5.700,00 TL |
| 1467.516.10 | 5 (3P+N+E) | 16 | 380-415 | 1 | 5.250,00 TL |
| 1467.532.10 | 5 (3P+N+E) | 32 | 380-415 | 1 | 6.100,00 TL |

İçten Kilitli Şalterli Pano Prizi (Dikey Tip)

IP44

6h

50/60 Hz.



| Ürün Kodu | Kutup | I(A) | Volt |  | Fiyat |
|-------------|------------|------|---------|---|-------------|
| 1944.316.15 | 3 (2P+E) | 16 | 200-250 | 1 | 3.400,00 TL |
| 1944.332.15 | 3 (2P+E) | 32 | 200-250 | 1 | 4.200,00 TL |
| 1944.416.15 | 4 (3P+E) | 16 | 380-415 | 1 | 3.750,00 TL |
| 1944.432.15 | 4 (3P+E) | 32 | 380-415 | 1 | 4.850,00 TL |
| 1444.516.15 | 5 (3P+N+E) | 16 | 380-415 | 1 | 4.200,00 TL |
| 1444.532.15 | 5 (3P+N+E) | 32 | 380-415 | 1 | 5.300,00 TL |

İçten Kilitli Şalterli Pano Prizi (Dikey Tip)

IP67

6h

50/60 Hz.



| Ürün Kodu | Kutup | I(A) | Volt |  | Fiyat |
|-------------|------------|------|---------|---|-------------|
| 1967.316.15 | 3 (2P+E) | 16 | 200-250 | 1 | 4.200,00 TL |
| 1967.332.15 | 3 (2P+E) | 32 | 200-250 | 1 | 5.100,00 TL |
| 1967.416.15 | 4 (3P+E) | 16 | 380-415 | 1 | 4.650,00 TL |
| 1967.432.15 | 4 (3P+E) | 32 | 380-415 | 1 | 5.500,00 TL |
| 1967.516.15 | 5 (3P+N+E) | 16 | 380-415 | 1 | 5.100,00 TL |
| 1967.532.15 | 5 (3P+N+E) | 32 | 380-415 | 1 | 5.950,00 TL |

İçten Kilitli Şalterli Duvar Prizi (Dikey Tip)

IP44

6h

50/60 Hz.



| Ürün Kodu | Kutup | I(A) | Volt |  | Fiyat |
|-------------|------------|------|---------|---|-------------|
| 1944.316.10 | 3 (2P+E) | 16 | 200-250 | 1 | 4.000,00 TL |
| 1944.332.10 | 3 (2P+E) | 32 | 200-250 | 1 | 4.650,00 TL |
| 1944.416.10 | 4 (3P+E) | 16 | 380-415 | 1 | 4.400,00 TL |
| 1944.432.10 | 4 (3P+E) | 32 | 380-415 | 1 | 5.300,00 TL |
| 1944.516.10 | 5 (3P+N+E) | 16 | 380-415 | 1 | 4.850,00 TL |
| 1944.532.10 | 5 (3P+N+E) | 32 | 380-415 | 1 | 5.750,00 TL |

İçten Kilitli Şalterli Duvar Prizi (Dikey Tip)

IP67

6h

50/60 Hz.



| Ürün Kodu | Kutup | I(A) | Volt |  | Fiyat |
|-------------|------------|------|---------|---|-------------|
| 1967.316.10 | 3 (2P+E) | 16 | 200-250 | 1 | 4.650,00 TL |
| 1967.332.10 | 3 (2P+E) | 32 | 200-250 | 1 | 5.500,00 TL |
| 1967.416.10 | 4 (3P+E) | 16 | 380-415 | 1 | 5.100,00 TL |
| 1967.432.10 | 4 (3P+E) | 32 | 380-415 | 1 | 5.950,00 TL |
| 1967.516.10 | 5 (3P+N+E) | 16 | 380-415 | 1 | 5.500,00 TL |
| 1967.532.10 | 5 (3P+N+E) | 32 | 380-415 | 1 | 6.400,00 TL |

İçten Kilitli Şalterli Sigortalı Pano Prizi

IP44

6h

50/60 Hz.



| Ürün Kodu | Kutup | I(A) | Volt |  | Fiyat |
|-------------|------------|------|---------|---|-------------|
| 1644.316.15 | 3 (2P+E) | 16 | 200-250 | 1 | 5.200,00 TL |
| 1644.332.15 | 3 (2P+E) | 32 | 200-250 | 1 | 6.500,00 TL |
| 1644.416.15 | 4 (3P+E) | 16 | 380-415 | 1 | 5.600,00 TL |
| 1644.432.15 | 4 (3P+E) | 32 | 380-415 | 1 | 7.200,00 TL |
| 1644.516.15 | 5 (3P+N+E) | 16 | 380-415 | 1 | 6.100,00 TL |
| 1644.532.15 | 5 (3P+N+E) | 32 | 380-415 | 1 | 7.650,00 TL |

İçten Kilitli Şalterli Sigortalı Pano Prizi

IP67

6h

50/60 Hz.



| Ürün Kodu | Kutup | I(A) | Volt |  | Fiyat |
|-------------|------------|------|---------|---|-------------|
| 1667.316.15 | 3 (2P+E) | 16 | 200-250 | 1 | 5.400,00 TL |
| 1667.332.15 | 3 (2P+E) | 32 | 200-250 | 1 | 6.750,00 TL |
| 1667.416.15 | 4 (3P+E) | 16 | 380-415 | 1 | 5.850,00 TL |
| 1667.432.15 | 4 (3P+E) | 32 | 380-415 | 1 | 7.400,00 TL |
| 1667.516.15 | 5 (3P+N+E) | 16 | 380-415 | 1 | 6.300,00 TL |
| 1667.532.15 | 5 (3P+N+E) | 32 | 380-415 | 1 | 7.850,00 TL |

İçten Kilitli Şalterli Sigortalı Duvar Prizi

IP44

6h

50/60 Hz.



| Ürün Kodu | Kutup | I(A) | Volt |  | Fiyat |
|-------------|------------|------|---------|---|-------------|
| 1644.316.10 | 3 (2P+E) | 16 | 200-250 | 1 | 5.850,00 TL |
| 1644.332.10 | 3 (2P+E) | 32 | 200-250 | 1 | 7.200,00 TL |
| 1644.416.10 | 4 (3P+E) | 16 | 380-415 | 1 | 6.300,00 TL |
| 1644.432.10 | 4 (3P+E) | 32 | 380-415 | 1 | 7.900,00 TL |
| 1644.516.10 | 5 (3P+N+E) | 16 | 380-415 | 1 | 6.750,00 TL |
| 1644.532.10 | 5 (3P+N+E) | 32 | 380-415 | 1 | 8.300,00 TL |

İçten Kilitli Şalterli Sigortalı Duvar Prizi

IP67

6h

50/60 Hz.



| Ürün Kodu | Kutup | I(A) | Volt |  | Fiyat |
|-------------|------------|------|---------|---|-------------|
| 1667.316.10 | 3 (2P+E) | 16 | 200-250 | 1 | 6.100,00 TL |
| 1667.332.10 | 3 (2P+E) | 32 | 200-250 | 1 | 7.600,00 TL |
| 1667.416.10 | 4 (3P+E) | 16 | 380-415 | 1 | 6.550,00 TL |
| 1667.432.10 | 4 (3P+E) | 32 | 380-415 | 1 | 8.100,00 TL |
| 1667.516.10 | 5 (3P+N+E) | 16 | 380-415 | 1 | 7.000,00 TL |
| 1667.532.10 | 5 (3P+N+E) | 32 | 380-415 | 1 | 8.550,00 TL |

| Ürün Kodu | IP44 Kombinasyon Kutuları |  | Fiyat |
|----------------------|--|---|--------------------|
| 341 | Boş Mbox | 1 | 700,00 TL |
| 341.364.30 | 3 Ad. 3x16A CEE | 1 | 1.950,00 TL |
| 341.324.30 | 3 Ad. 3x32A CEE | 1 | 2.400,00 TL |
| 341.464.30 | 3 Ad. 4x16A CEE | 1 | 2.160,00 TL |
| 341.424.30 | 3 Ad. 4x32A CEE | 1 | 2.640,00 TL |
| 341.564.30 | 3 Ad. 5x16A CEE | 1 | 2.400,00 TL |
| 341.524.30 | 3 Ad. 5x32A CEE | 1 | 2.925,00 TL |
| 341.524.164.210 | 2 Ad. 5x32A CEE + 1 Ad. 1x16A Makine Prizi | 1 | 2.365,00 TL |
| 341.524.164.120 | 1 Ad. 5x32A CEE + 2 Ad. 1x16A Makine Prizi | 1 | 1.855,00 TL |
| 341.524.564.164.1110 | 1 Ad. 5x32A CEE + 1 Ad. 5x16A CEE + 1 Ad. 1x16A Makine Prizi | 1 | 2.215,00 TL |
| 341.215.311.60 | 6 Ad. Şebeke Pano prizi | 1 | 1.740,00 TL |
| 341.215.321.60 | 6 Ad. UPS Pano prizi | 1 | 1.800,00 TL |



| Ürün Kodu | IP67 Kombinasyon Kutuları |  | Fiyat |
|----------------------|--|---|--------------------|
| 361 | Boş Mbox | 1 | 850,00 TL |
| 361.324.30 | 3 Ad. 3x32A CEE | 1 | 3.270,00 TL |
| 361.464.30 | 3 Ad. 4x16A CEE | 1 | 2.970,00 TL |
| 361.424.30 | 3 Ad. 4x32A CEE | 1 | 3.450,00 TL |
| 361.564.30 | 3 Ad. 5x16A CEE | 1 | 3.150,00 TL |
| 361.524.30 | 3 Ad. 5x32A CEE | 1 | 3.675,00 TL |
| 361.524.164.210 | 2 Ad.5X32A CEE IP67 +1 Ad.1x16 IP67 Makine prizi | 1 | 3.020,00 TL |
| 361.524.164.120 | 1 Ad.5x32A CEE IP67+2 Ad.1x16 IP 67 Makine prizi | 1 | 2.365,00 TL |
| 361.524.564.164.1110 | 1 Ad.5x32A CEE IP 67 +1Ad. 5x16A CEE IP 67 +1 Ad.1x16 IP 67 Makine Prizi | 1 | 2.845,00 TL |

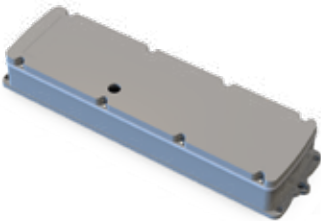

260x350mm Priz Montajlı Sigortalı Kombinasyon Kutuları (12 Sigorta Kapasiteli)

| Ürün Kodu | IP44 Kombinasyon Kutuları |  | Fiyat |
|-----------------|--|---|--------------------|
| E.44120 | Boş Ecobox | 1 | 1.000,00 TL |
| E.4412.3160.024 | 2 Ad. IP44 3x16A CEE Ön + 4 Ad. IP44 1x16A Ön | 1 | 2.160,00 TL |
| E.4412.3320.024 | 2 Ad. IP44 3x32A CEE Ön + 4 Ad. IP44 1x16A Ön | 1 | 2.460,00 TL |
| E.4412.4160.024 | 2 Ad. IP44 4x16A CEE Ön + 4 Ad. IP44 1x16A Ön | 1 | 2.300,00 TL |
| E.4412.4320.024 | 2 Ad. IP44 4x32A CEE Ön + 4 Ad. IP44 1x16A Ön | 1 | 2.620,00 TL |
| E.4412.5160.024 | 2 Ad. IP44 5x16A CEE Ön + 4 Ad. IP44 1x16A Yan | 1 | 2.460,00 TL |
| E.4412.5320.024 | 2 Ad. IP44 5x32A CEE Ön + 4 Ad. IP44 1x16A Yan | 1 | 2.810,00 TL |

| Ürün Kodu | IP67 Kombinasyon Kutuları |  | Fiyat |
|-----------------|--|---|--------------------|
| E.64120 | Boş Ecobox | 1 | 1.100,00 TL |
| E.6412.3161.024 | 2 Ad. IP67 3x16A CEE Ön + 4 Ad. IP44 1x16A Ön | 1 | 2.500,00 TL |
| E.6412.3321.024 | 2 Ad. IP67 3x32A CEE Ön + 4 Ad. IP44 1x16A Ön | 1 | 3.040,00 TL |
| E.6412.4161.024 | 2 Ad. IP67 4x16A CEE Ön + 4 Ad. IP44 1x16A Ön | 1 | 2.840,00 TL |
| E.6412.4321.024 | 2 Ad. IP67 4x32A CEE Ön + 4 Ad. IP44 1x16A Ön | 1 | 3.160,00 TL |
| E.6412.5161.024 | 2 Ad. IP67 5x16A CEE Ön + 4 Ad. IP44 1x16A Yan | 1 | 2.960,00 TL |
| E.6412.5321.024 | 2 Ad. IP67 5x32A CEE Ön + 4 Ad. IP44 1x16A Yan | 1 | 3.310,00 TL |



E.6212



E.4212.3160.024



E.4212.4320.024



E.62120.5321.024



E.4412.5320.024

260x350mm Priz Montajlı Sigortalı Kombinasyon Kutuları (12 Sigorta Kapasiteli)

HALOJEN FREE

| Ürün Kodu | IP44 Kombinasyon Kutuları |  | Fiyat |
|---------------------|--|---|--------------------|
| 44120 | 260x350x120mm IP44 Boş Kombinasyon Kutusu | 1 | 1.150,00 TL |
| 44120.4160.1160.224 | 2 Ad. IP44 4x16A CEE + 2 Ad. IP44 1x16A Ön + 4 Ad. IP44 1x16A Yan | 1 | 2.680,00 TL |
| 44120.3163.0000.044 | 4 Ad. IP44 3x16A Ön + 4 Ad. 1x16 Yan | 1 | 3.010,00 TL |
| 44120.3323.3163.224 | 2 Ad. IP44 3x32A Ön + 2 Ad. IP44 3x16 Ön + 4 Ad. 1x16A Yan | 1 | 3.310,00 TL |
| 44120.3323.0000.044 | 4 Ad. IP44 3x32A Ön + 4 Ad. 1x16A Yan | 1 | 3.610,00 TL |
| 44120.4320.4250.222 | 2 Ad. IP44 4x32A CEE Ön + 2 Ad. IP44 4x25A Ön + 2 Ad. 1x16A Yan | 1 | 3.450,00 TL |
| 44120.4250.0000.044 | 4 Ad. IP44 4x25A Ön + 4 Ad. 1x16A Yan | 1 | 3.070,00 TL |
| 44120.4320.0000.046 | 4 Ad. IP44 4x32A CEE Ön + 6 Ad. 1x16A Yan | 1 | 4.160,00 TL |
| 44120.4630.0000.028 | 2 Ad. IP44 4x63A CEE Ön + 4 Ad. 1x16A Ön + 4 Ad. 1x16 Yan | 1 | 5.370,00 TL |
| 44120.5160.0000.022 | 2 Ad. IP44 5x16A CEE Ön + 2 Ad. 1x16 Yan | 1 | 2.380,00 TL |
| 44120.5320.0000.022 | 2 Ad. IP44 5x32A CEE Ön + 2 Ad. 1x16 Yan | 1 | 2.730,00 TL |
| 44120.5320.5160.222 | 2 Ad. IP44 5x32A CEE Ön + 2 Ad. IP44 5x16A CEE Ön + 2 Ad. 1x16 Yan | 1 | 3.730,00 TL |

| Ürün Kodu | IP67 Kombinasyon Kutuları |  | Fiyat |
|---------------------|---|---|--------------------|
| 64120 | 260x350x120mm IP67 Boş Kombinasyon Kutusu | 1 | 1.250,00 TL |
| 64120.4160.1160.224 | 2 Ad. IP44 4x16A CEE + 2 Ad. IP44 1x16A Ön + 4 Ad. IP44 1x16A Yan | 1 | 2.780,00 TL |
| 64120.3163.0000.044 | 4 Ad. IP44 3x16A Ön + 4 Ad. 1x16 Yan | 1 | 3.110,00 TL |
| 64120.3323.3163.224 | 2 Ad. IP44 3x32A Ön + 2 Ad. IP44 3x16 Ön + 4 Ad. 1x16A Yan | 1 | 3.410,00 TL |
| 64120.3323.0000.044 | 4 Ad. IP44 3x32A Ön + 4 Ad. 1x16A Yan | 1 | 3.710,00 TL |
| 64120.4320.4250.222 | 2 Ad. IP44 4x32A CEE Ön + 2 Ad. IP44 4x25A Ön + 2 Ad. 1x16A Yan | 1 | 3.750,00 TL |
| 64120.4250.0000.044 | 4 Ad. IP44 4x25A Ön + 4 Ad. 1x16A Yan | 1 | 3.337,00 TL |
| 64120.4320.0000.046 | 4 Ad. IP44 4x32A CEE Ön + 6 Ad. 1x16A Yan | 1 | 4.260,00 TL |
| 64120.4321.0000.044 | 4 Ad. IP67 4x32A CEE Ön + 4 Ad. 1x16A Yan | 1 | 4.910,00 TL |
| 64120.4631.4321.222 | 2 Ad. IP67 4x63A CEE Ön + 2 Ad. IP67 4x32A CEE Ön + 2 Ad. 1x16 Yan | 1 | 8.580,00 TL |
| 64120.4630.0000.028 | 2 Ad. IP44 4x63A CEE Ön + 4 Ad. 1x16A Ön + 4 Ad. 1x16 Yan | 1 | 5.470,00 TL |
| 64120.5160.0000.022 | 2 Ad. IP44 5x16A CEE Ön + 2 Ad. 1x16 Yan | 1 | 2.480,00 TL |
| 64120.5320.0000.022 | 2 Ad. IP44 5x32A CEE Ön + 2 Ad. 1x16 Yan | 1 | 2.830,00 TL |
| 64120.5320.5160.222 | 2 Ad. IP44 5x32A CEE Ön + 2 Ad. IP44 5x16A CEE Ön + 2 Ad. 1x16 Yan | 1 | 3.830,00 TL |
| 64120.5321.0000.046 | 4 Ad. IP67 5x32A CEE Ön + 6 Ad. 1x16A Yan | 1 | 5.440,00 TL |
| 64120.5631.5321.222 | 2 Ad. IP67 5x63A CEE Ön + 2 Ad. IP67 5x32A CEE Ön + 2 Ad. 1x16A Yan | 1 | 8.130,00 TL |



64120



64120.4160.0000.028



64120.4160.3160.224



64120.5320.5160.224



64120.4321.5321.220

210x280mm Priz Montajlı Sigortalı Kombinasyon Kutuları (10 Sigorta Kapasiteli)

HALOJEN FREE

| Ürün Kodu | IP44 Kombinasyon Kutuları |  | Fiyat |
|---------------------|---|---|--------------------|
| 42100 | 210x280x100mm IP44 Boş Kombinasyon Kutusu | 1 | 950,00 TL |
| 42100.4160.0000.011 | 1 Ad. IP44 4x16A CEE Ön + 1 Ad. 1x16A Ön | 1 | 1.485,00 TL |
| 42100.4160.0000.012 | 1 Ad. IP44 4x16A CEE Ön + 2 Ad. 1x16A Ön | 1 | 1.600,00 TL |
| 42100.4160.0000.022 | 2 Ad. IP44 4x16A CEE Ön + 2 Ad. 1x16A Yan | 1 | 2.020,00 TL |
| 42100.4250.0000.022 | 2 Ad. IP44 4x25A Ön + 2 Ad. 1x16A Yan | 1 | 1.729,00 TL |
| 42100.4320.0000.022 | 2 Ad. IP44 4x32A CEE Ön + 2 Ad. 1x16A Yan | 1 | 2.340,00 TL |
| 42100.5160.0000.022 | 2 Ad. IP44 5x16A CEE Ön + 2 Ad. 1x16A Yan | 1 | 2.180,00 TL |
| 42100.5160.0000.012 | 1 Ad. IP44 5x16A CEE Ön + 2 Ad. 1x16A Ön | 1 | 1.680,00 TL |
| 42100.5320.0000.012 | 1 Ad. IP44 5x32A CEE Ön + 2 Ad. 1x16A Ön | 1 | 1.855,00 TL |
| 42100.5320.0000.022 | 2 Ad. IP44 5x32A CEE Ön + 2 Ad. 1x16A Yan | 1 | 2.530,00 TL |
| 42100.5320.5160.112 | 1 Ad. IP44 5x32A CEE Ön + 1 Ad. IP44 5x16A CEE Ön + 2 Ad. 1x16A Yan | 1 | 2.355,00 TL |
| 42100.3163.0000.022 | 2 Ad. IP44 3x16A Ön + 2 Ad. 1x16A Yan | 1 | 1.880,00 TL |
| 42100.3323.3163.112 | 1 Ad. IP44 3x32A Ön + 1 Ad. IP44 3x16A Ön + 2 Ad. 1x16A Yan | 1 | 2.030,00 TL |
| 42100.3323.0000.022 | 2 Ad. IP44 3x32A Ön + 2 Ad. 1x16A Yan | 1 | 2.180,00 TL |

| Ürün Kodu | IP67 Kombinasyon Kutuları |  | Fiyat |
|---------------------|---|--|--------------------|
| 62100 | 210x280x100mm IP67 Boş Kombinasyon Kutusu | 1 | 1.050,00 TL |
| 62100.4160.0000.011 | 1 Ad. IP44 4x16A CEE Ön + 1 Ad. 1x16A Ön | 1 | 1.585,00 TL |
| 62100.4160.0000.012 | 1 Ad. IP44 4x16A CEE Ön + 2 Ad. 1x16A Ön | 1 | 1.700,00 TL |
| 62100.4160.0000.022 | 2 Ad. IP44 4x16A CEE Ön + 2 Ad. 1x16A Yan | 1 | 2.120,00 TL |
| 62100.4250.0000.022 | 2 Ad. IP44 4x25A Ön + 2 Ad. 1x16A Yan | 1 | 1.828,00 TL |
| 62100.4320.0000.022 | 2 Ad. IP44 4x32A CEE Ön + 2 Ad. 1x16A Yan | 1 | 2.440,00 TL |
| 62100.4321.0000.024 | 2 Ad. IP67 4x32A CEE Ön + 4 Ad. 1x16A Yan | 1 | 3.110,00 TL |
| 62100.5160.0000.022 | 2 Ad. IP44 5x16A CEE Ön + 2 Ad. 1x16A Yan | 1 | 2.280,00 TL |
| 62100.5160.0000.012 | 1 Ad. IP44 5x16A CEE Ön + 2 Ad. 1x16A Ön | 1 | 1.780,00 TL |
| 62100.5320.0000.012 | 1 Ad. IP44 5x32A CEE Ön + 2 Ad. 1x16A Ön | 1 | 1.955,00 TL |
| 62100.5320.0000.022 | 2 Ad. IP44 5x32A CEE Ön + 2 Ad. 1x16A Yan | 1 | 2.630,00 TL |
| 62100.5320.5160.112 | 1 Ad. IP44 5x32A CEE Ön + 1 Ad. IP44 5x16A CEE Ön + 2 Ad. 1x16A Yan | 1 | 2.455,00 TL |
| 62100.3163.0000.022 | 2 Ad. IP44 3x16A Ön + 2 Ad. 1x16A Yan | 1 | 1.980,00 TL |
| 62100.3323.3163.112 | 1 Ad. IP44 3x32A Ön + 1 Ad. IP44 3x16A Ön + 2 Ad. 1x16A Yan | 1 | 2.130,00 TL |
| 62100.3323.0000.022 | 2 Ad. IP44 3x32A Ön + 2 Ad. 1x16A Yan | 1 | 2.280,00 TL |



62100



62100.3163.0000.022



62100.4160.0000.012



62100.4320.0000.022



62100.5321.0000.020

210x280mm Priz Montajlı Sigortalı Kombinasyon Kutuları (8 Sigorta Kapasiteli)

HALOJEN FREE

| Ürün Kodu | IP44 Kombinasyon Kutuları |  | Fiyat |
|---------------------|---|---|--------------------|
| 42080 | 210x280x100mm IP44 Boş Kombinasyon Kutusu | 1 | 800,00 TL |
| 42080.4160.0000.011 | 1 Ad. IP44 4x16A CEE Ön + 1 Ad. 1x16A Ön | 1 | 1.335,00 TL |
| 42080.4160.0000.012 | 1 Ad. IP44 4x16A CEE Ön + 2 Ad. 1x16A Ön | 1 | 1.450,00 TL |
| 42080.4160.0000.022 | 2 Ad. IP44 4x16A CEE Ön + 2 Ad. 1x16A Yan | 1 | 1.870,00 TL |
| 42080.4250.0000.022 | 2 Ad. IP44 4x25A Ön + 2 Ad. 1x16A Yan | 1 | 1.600,00 TL |
| 42080.4320.0000.022 | 2 Ad. IP44 4x32A CEE Ön + 2 Ad. 1x16A Yan | 1 | 2.190,00 TL |
| 42080.5160.0000.022 | 2 Ad. IP44 5x16A CEE Ön + 2 Ad. 1x16A Yan | 1 | 2.030,00 TL |
| 42080.5160.0000.012 | 1 Ad. IP44 5x16A CEE Ön + 2 Ad. 1x16A Ön | 1 | 1.530,00 TL |
| 42080.5320.0000.012 | 1 Ad. IP44 5x32A CEE Ön + 2 Ad. 1x16A Ön | 1 | 1.705,00 TL |
| 42080.5320.0000.022 | 2 Ad. IP44 5x32A CEE Ön + 2 Ad. 1x16A Yan | 1 | 2.380,00 TL |
| 42080.3163.0000.022 | 2 Ad. IP44 3x16A Ön + 2 Ad. 1x16A Yan | 1 | 1.730,00 TL |
| 42080.3323.3163.112 | 1 Ad. IP44 3x32A Ön + 1 Ad. IP44 3x16A Ön + 2 Ad. 1x16A Yan | 1 | 1.880,00 TL |
| 42080.3323.0000.022 | 2 Ad. IP44 3x32A Ön + 2 Ad. 1x16A Yan | 1 | 2.030,00 TL |

| Ürün Kodu | IP67 Kombinasyon Kutuları |  | Fiyat |
|---------------------|---|--|--------------------|
| 62080 | 210x280x100mm IP67 Boş Kombinasyon Kutusu | 1 | 900,00 TL |
| 62080.4160.0000.011 | 1 Ad. IP44 4x16A CEE Ön + 1 Ad. 1x16A Ön | 1 | 1.435,00 TL |
| 62080.4160.0000.012 | 1 Ad. IP44 4x16A CEE Ön + 2 Ad. 1x16A Ön | 1 | 1.550,00 TL |
| 62080.4160.0000.022 | 2 Ad. IP44 4x16A CEE Ön + 2 Ad. 1x16A Yan | 1 | 1.970,00 TL |
| 62080.4250.0000.022 | 2 Ad. IP44 4x25A Ön + 2 Ad. 1x16A Yan | 1 | 1.800,00 TL |
| 62080.4320.0000.022 | 2 Ad. IP44 4x32A CEE Ön + 2 Ad. 1x16A Yan | 1 | 2.290,00 TL |
| 62080.4321.0000.024 | 2 Ad. IP67 4x32A CEE Ön + 4 Ad. 1x16A Yan | 1 | 2.960,00 TL |
| 62080.5160.0000.022 | 2 Ad. IP44 5x16A CEE Ön + 2 Ad. 1x16A Yan | 1 | 2.130,00 TL |
| 62080.5160.0000.012 | 1 Ad. IP44 5x16A CEE Ön + 2 Ad. 1x16A Ön | 1 | 1.630,00 TL |
| 62080.5320.0000.012 | 1 Ad. IP44 5x32A CEE Ön + 2 Ad. 1x16A Ön | 1 | 1.805,00 TL |
| 62080.5320.0000.022 | 2 Ad. IP44 5x32A CEE Ön + 2 Ad. 1x16A Yan | 1 | 2.480,00 TL |
| 62080.3163.0000.022 | 2 Ad. IP44 3x16A Ön + 2 Ad. 1x16A Yan | 1 | 1.830,00 TL |
| 62080.3323.3163.112 | 1 Ad. IP44 3x32A Ön + 1 Ad. IP44 3x16A Ön + 2 Ad. 1x16A Yan | 1 | 1.980,00 TL |
| 62080.3323.0000.022 | 2 Ad. IP44 3x32A Ön + 2 Ad. 1x16A Yan | 1 | 1.130,00 TL |



62080



62080.3160.0000.022



62080.4160.0000.012



62080.4320.0000.022



452.5321.0000.020

135x250mm Priz Montajlı Sigortalı Kombinasyon Kutuları (6 Sigorta Kapasiteli)

HALOJEN FREE

| Ürün Kodu | IP44 Kombinasyon Kutuları | | Fiyat |
|---------------------|---|--|----------------------|
| 41060 | 135x250x120mm IP44 Boş Kombinasyon Kutusu |  | 2 600,00 TL |
| 41060.3163.0000.012 | 1 Ad. IP44 3x16A Ön + 2 Ad. 1x16A Yan | | 2 1.180,00 TL |
| 41060.3323.0000.012 | 1 Ad. IP44 3x32A Ön + 2 Ad. 1x16A Yan | | 2 1.330,00 TL |
| 41060.4250.0000.012 | 1 Ad. IP44 4x25A Ön + 2 Ad. 1x16A Yan | | 2 1.200,00 TL |
| 41060.4160.0000.012 | 1 Ad. IP44 4x16A CEE Ön + 2 Ad. 1x16A Yan | | 2 1.250,00 TL |
| 41060.4320.0000.012 | 1 Ad. IP44 4x32A CEE Ön + 2 Ad. 1x16A Yan | | 2 1.410,00 TL |
| 41060.5160.0000.012 | 1 Ad. IP44 5x16A CEE Ön + 2 Ad. 1x16A Yan | | 2 1.330,00 TL |
| 41060.5320.0000.012 | 1 Ad. IP44 5x32A CEE Ön + 2 Ad. 1x16A Yan | | 2 1.505,00 TL |

41060

| Ürün Kodu | IP67 Kombinasyon Kutuları | | Fiyat |
|---------------------|---|---|----------------------|
| 61060 | 135x250x120mm IP67 Boş Kombinasyon Kutusu |  | 2 700,00 TL |
| 61060.3163.0000.012 | 1 Ad. IP44 3x16A Ön + 2 Ad. 1x16A Yan | | 2 1.280,00 TL |
| 61060.3323.0000.012 | 1 Ad. IP44 3x32A Ön + 2 Ad. 1x16A Yan | | 2 1.430,00 TL |
| 61060.4250.0000.012 | 1 Ad. IP44 4x25A Ön + 2 Ad. 1x16A Yan | | 2 1.400,00 TL |
| 61060.4160.0000.012 | 1 Ad. IP44 4x16A CEE Ön + 2 Ad. 1x16A Yan | | 2 1.350,00 TL |
| 61060.4320.0000.012 | 1 Ad. IP44 4x32A CEE Ön + 2 Ad. 1x16A Yan | | 2 1.510,00 TL |
| 61060.5160.0000.012 | 1 Ad. IP44 5x16A CEE Ön + 2 Ad. 1x16A Yan | | 2 1.430,00 TL |
| 61060.5320.0000.012 | 1 Ad. IP44 5x32A CEE Ön + 2 Ad. 1x16A Yan | | 2 1.605,00 TL |

61060.5320.0000.012

113x210mm Priz Montajlı Sigortalı Kombinasyon Kutuları (4 Sigorta Kapasiteli)

HALOJEN FREE



| Ürün Kodu | IP44 Kombinasyon Kutuları | | Fiyat |
|---------------------|---|--|----------------------|
| 41040 | 113x210x90mm IP44 Boş Kombinasyon Kutusu |  | 3 500,00 TL |
| 41040.3163.0000.012 | 1 Ad. IP44 3x16A Ön + 2 Ad. 1x16A Yan | | 3 1.080,00 TL |
| 41040.3323.0000.012 | 1 Ad. IP44 3x32A Ön + 2 Ad. 1x16A Yan | | 3 1.230,00 TL |
| 41040.4250.0000.012 | 1 Ad. IP44 4x25A Ön + 2 Ad. 1x16A Yan | | 3 1.000,00 TL |
| 41040.4160.0000.012 | 1 Ad. 1P44 4x16A CEE Ön + 2 Ad. 1x16A Yan | | 3 1.150,00 TL |
| 41040.4320.0000.012 | 1 Ad. 1P44 4x32A CEE Ön + 2 Ad. 1x16A Yan | | 3 1.310,00 TL |
| 41040.5160.0000.012 | 1 Ad. 1P44 5x16A CEE Ön + 2 Ad. 1x16A Yan | | 3 1.230,00 TL |
| 41040.5320.0000.012 | 1 Ad. 1P44 5x32A CEE Ön + 2 Ad. 1x16A Yan | | 3 1.405,00 TL |

41040

| Ürün Kodu | IP67 Kombinasyon Kutuları | | Fiyat |
|---------------------|---|--|----------------------|
| 61040 | 113x210x90mm IP67 Boş Kombinasyon Kutusu |  | 3 550,00 TL |
| 61040.3163.0000.012 | 1 Ad. IP44 3x16A Ön + 2 Ad. 1x16A Yan | | 3 1.130,00 TL |
| 61040.3323.0000.012 | 1 Ad. IP44 3x32A Ön + 2 Ad. 1x16A Yan | | 3 1.280,00 TL |
| 61040.4250.0000.012 | 1 Ad. IP44 4x25A Ön + 2 Ad. 1x16A Yan | | 3 1.100,00 TL |
| 61040.4160.0000.012 | 1 Ad. 1P44 4x16A CEE Ön + 2 Ad. 1x16A Yan | | 3 1.200,00 TL |
| 61040.4320.0000.012 | 1 Ad. 1P44 4x32A CEE Ön + 2 Ad. 1x16A Yan | | 3 1.360,00 TL |
| 61040.5160.0000.012 | 1 Ad. 1P44 5x16A CEE Ön + 2 Ad. 1x16A Yan | | 3 1.280,00 TL |
| 61040.5320.0000.012 | 1 Ad. 1P44 5x32A CEE Ön + 2 Ad. 1x16A Yan | | 3 1.455,00 TL |

61040.5320.0000.012

Priz Montajlı Sigortasız Kombinasyon Kutuları

| Ürün Kodu | IP44 Kombinasyon Kutuları |  | Fiyat |
|---------------------|---|---|--------------------|
| 41000 | 113x113x73mm IP44 Boş Kombinasyon Kutusu | 6 | 230,00 TL |
| 41000.4160.0000.012 | 1 Ad. IP44 4x16A CEE Ön + 2 Ad. 1x16A Yan | 6 | 880,00 TL |
| 41000.5160.0000.012 | 1 Ad. IP44 5x16A CEE Ön + 2 Ad. 1x16A Yan | 6 | 960,00 TL |
| 42000 | 210x113x73mm IP44 Boş Kombinasyon Kutusu | 3 | 360,00 TL |
| 42000.4320.0000.022 | 2 Ad. IP44 4x32A CEE Ön + 2 Ad. 1x16A Yan | 3 | 1.750,00 TL |
| 42000.5320.0000.022 | 2 Ad. IP44 5x32A CEE Ön + 2 Ad. 1x16A Yan | 3 | 1.940,00 TL |
| Ürün Kodu | IP67 Kombinasyon Kutuları |  | Fiyat |
| 61000 | 113x113x73mm IP67 Boş Kombinasyon Kutusu | 6 | 280,00 TL |
| 61000.4160.0000.012 | 1 Ad. IP44 4x16A CEE Ön + 2 Ad. 1x16A Yan | 6 | 930,00 TL |
| 61000.5160.0000.012 | 1 Ad. IP44 5x16A CEE Ön + 2 Ad. 1x16A Yan | 6 | 1.010,00 TL |
| 62000 | 210x113x73mm IP67 Boş Kombinasyon Kutusu | 3 | 390,00 TL |
| 62000.4320.0000.022 | 2 Ad. IP44 4x32A CEE Ön + 2 Ad. 1x16A Yan | 3 | 1.780,00 TL |
| 62000.5320.0000.022 | 2 Ad. IP44 5x32A CEE Ön + 2 Ad. 1x16A Yan | 3 | 1.970,00 TL |



62000.5320.0000.022



61000.4160.0000.012

Opak Kapaklı Termoplastik Buatlar

HALOJEN FREE

| IP44 Ürün Kodu | IP67 Ürün Kodu | Dış Ölçü(mm) |  | IP44 Fiyat | IP67 Fiyat |
|----------------|----------------|-----------------|--|--------------------|--------------------|
| 344.041.101 | - | 85 x 85 x 41 | 24 | 79,00 TL | |
| 344.055.201 | 367.055.201 | 95 x 95 x 55 | 12 | 121,00 TL | 126,00 TL |
| 344.073.301 | 367.073.301 | 113 x 113 x 73 | 12 | 226,00 TL | 237,00 TL |
| 344.120.301 | 367.120.301 | 113 x 113 x 120 | 6 | 231,00 TL | 289,00 TL |
| 344.073.401 | 367.073.401 | 113 x 210 x 73 | 6 | 368,00 TL | 403,00 TL |
| 344.120.401 | 367.120.401 | 113 x 210 x 120 | 3 | 405,00 TL | 424,00 TL |
| 344.085.421 | 367.085.421 | 130 x 245 x 85 | 2 | 455,00 TL | 478,00 TL |
| 344.140.421 | 367.140.421 | 130 x 245 x 140 | 2 | 559,00 TL | 587,00 TL |
| 344.100.501 | 367.100.501 | 210 x 280 x 100 | 1 | 735,00 TL | 770,00 TL |
| 344.135.601 | 367.135.601 | 210 x 280 x 135 | 1 | 758,00 TL | 797,00 TL |
| 344.115.501 | 367.115.501 | 260 x 350 x 115 | 1 | 1.150,00 TL | 1.208,00 TL |
| 344.145.601 | 367.145.601 | 260 x 350 x 145 | 1 | 1.234,00 TL | 1.297,00 TL |
| 344.155.601 | 367.155.601 | 260 x 350 x 155 | 1 | 1.264,00 TL | 1.327,00 TL |
| 344.185.601 | 367.185.601 | 260 x 350 x 185 | 1 | 1.364,00 TL | 1.432,00 TL |



367.073.301



367.073.401



367.100.501



367.135.601



367.155.601

Şeffaf Kapaklı Termoplastik Buatlar

HALOJEN FREE

| IP44 Ürün Kodu | IP67 Ürün Kodu | Dış Ölçü(mm) |  | IP44 Fiyat | IP67 Fiyat |
|----------------|----------------|-----------------|--|--------------------|--------------------|
| 344.055.202 | 367.055.202 | 95 x 95 x 55 | 12 | 137,00 TL | 142,00 TL |
| 344.073.302 | 367.073.302 | 113 x 113 x 73 | 12 | 223,00 TL | 233,00 TL |
| 344.120.302 | 367.120.302 | 113 x 113 x 120 | 6 | 279,00 TL | 293,00 TL |
| 344.073.402 | 367.073.402 | 113 x 210 x 73 | 6 | 345,00 TL | 363,00 TL |
| 344.120.402 | 367.120.402 | 113 x 210 x 120 | 3 | 471,00 TL | 494,00 TL |
| 344.085.422 | 367.085.422 | 130 x 245 x 85 | 2 | 501,00 TL | 527,00 TL |
| 344.140.422 | 367.140.422 | 130 x 245 x 140 | 2 | 564,00 TL | 592,00 TL |
| 344.100.502 | 367.100.502 | 210 x 280 x 100 | 1 | 814,00 TL | 856,00 TL |
| 344.135.602 | 367.135.602 | 210 x 280 x 135 | 1 | 861,00 TL | 905,00 TL |
| 344.115.502 | 367.115.502 | 260 x 350 x 115 | 1 | 1.295,00 TL | 1.360,00 TL |
| 344.145.602 | 367.145.602 | 260 x 350 x 145 | 1 | 1.379,00 TL | 1.448,00 TL |
| 344.155.602 | 367.155.602 | 260 x 350 x 155 | 1 | 1.385,00 TL | 1.455,00 TL |
| 344.185.602 | 367.185.602 | 260 x 350 x 185 | 1 | 1.479,00 TL | 1.553,00 TL |



367.073.302



367.073.402



367.100.502



367.135.602



367.155.602

Metal Montaj Plakalı

IP65

HALOJEN FREE

| Ürün Kodu | | Ölçü(cm) |  | Fiyat | |
|--------------------|--------------------|--------------|--|-------------|--------------|
| Opak Kapak | Şeffaf Kapak | | | Opak Kapak | Şeffaf Kapak |
| 910.2130.131.000.M | 910.2130.132.000.M | 21 x 30 x 13 | 20 | 926,00 TL | 972,00 TL |
| 910.2635.151.000.M | 910.2635.152.000.M | 26 x 35 x 15 | 12 | 1.250,00 TL | 1.320,00 TL |
| 910.2635.181.000.M | 910.2635.182.000.M | 26 x 35 x 18 | 12 | 1.315,00 TL | 1.375,00 TL |
| 910.3040.131.000.M | 910.3040.132.000.M | 30 x 40 x 13 | 10 | 1.510,00 TL | 1.626,00 TL |
| 910.3040.171.000.M | 910.3040.172.000.M | 30 x 40 x 17 | 8 | 1.521,00 TL | 1.690,00 TL |
| 910.3040.191.000.M | 910.3040.192.000.M | 30 x 40 x 19 | 8 | 1.790,00 TL | 1.944,00 TL |
| 910.3040.231.000.M | 910.3040.232.000.M | 30 x 40 x 23 | 8 | 1.842,00 TL | 1.968,00 TL |
| 910.4050.201.000.M | 910.4050.202.000.M | 40 x 50 x 20 | 6 | 2.698,00 TL | 2.997,00 TL |
| 910.4060.201.000.M | 910.4060.202.000.M | 40 x 60 x 20 | 6 | 2.900,00 TL | 3.708,00 TL |
| 910.5070.251.000.M | 910.5070.252.000.M | 50 x 70 x 25 | 4 | 4.550,00 TL | 5.174,00 TL |

Plastik Montaj Plakalı

IP65

HALOJEN FREE

| Ürün Kodu | | Ölçü(cm) |  | Fiyat | |
|------------------|------------------|--------------|--|-------------|--------------|
| Opak Kapak | Şeffaf Kapak | | | Opak Kapak | Şeffaf Kapak |
| 910.2130.131.000 | 910.2130.132.000 | 21 x 30 x 13 | 20 | 910,00 TL | 950,00 TL |
| 910.2635.151.000 | 910.2635.152.000 | 26 x 35 x 15 | 12 | 1.225,00 TL | 1.300,00 TL |
| 910.2635.181.000 | 910.2635.182.000 | 26 x 35 x 18 | 12 | 1.285,00 TL | 1.345,00 TL |
| 910.3040.131.000 | 910.3040.132.000 | 30 x 40 x 13 | 10 | 1.485,00 TL | 1.600,00 TL |
| 910.3040.171.000 | 910.3040.172.000 | 30 x 40 x 17 | 8 | 1.495,00 TL | 1.664,00 TL |
| 910.3040.191.000 | 910.3040.192.000 | 30 x 40 x 19 | 8 | 1.750,00 TL | 1.900,00 TL |
| 910.3040.231.000 | 910.3040.232.000 | 30 x 40 x 23 | 8 | 1.800,00 TL | 1.924,00 TL |
| 910.4050.201.000 | 910.4050.202.000 | 40 x 50 x 20 | 6 | 2.638,00 TL | 2.930,00 TL |
| 910.4060.201.000 | 910.4060.202.000 | 40 x 60 x 20 | 6 | 2.844,00 TL | 3.626,00 TL |
| 910.5070.251.000 | 910.5070.252.000 | 50 x 70 x 25 | 4 | 4.480,00 TL | 5.104,00 TL |



910.2130.132.000



910.2635.151.000



910.3040.232.000



910.4050.201.000

Plastik Perdeli

IP65

HALOJEN FREE

| Ürün Kodu | | Ölçü(cm) | Açıklama | 📦 | Fiyat | |
|------------------|------------------|--------------|----------------|----|--------------------|--------------------|
| Opak Kapak | Şeffaf Kapak | | | | Opak Kapak | Şeffaf Kapak |
| 920.2130.131.014 | 920.2130.132.014 | 21 x 30 x 13 | 2 x 7 Sigorta | 20 | 1458,00 TL | 1560,00 TL |
| 920.2635.151.020 | 920.2635.152.020 | 26 x 35 x 15 | 2 x 10 Sigorta | 12 | 1.710,00 TL | 1.860,00 TL |
| 920.3040.131.036 | 920.3040.132.036 | 30 x 40 x 13 | 3 x 12 Sigorta | 10 | 2.025,00 TL | 2.140,00 TL |
| 920.3040.171.036 | 920.3040.172.036 | 30 x 40 x 17 | 3 x 12 Sigorta | 8 | 2.160,00 TL | 2.396,00 TL |
| 920.4050.201.048 | 920.4050.202.048 | 40 x 50 x 20 | 3 x 16 Sigorta | 6 | 3.896,00 TL | 4.246,00 TL |
| 920.4060.201.064 | 920.4060.202.064 | 40 x 60 x 20 | 4 x 16 Sigorta | 6 | 4.374,00 TL | 5.152,00 TL |
| 920.5070.251.100 | 920.5070.252.100 | 50 x 70 x 25 | 5 x 20 Sigorta | 4 | 6.095,00 TL | 6.970,00 TL |



920.2635.151.020



920.3040.172.036



920.4050.201.048



920.4060.202.064

Perdeli + Kompakt Şalterli

IP65

HALOJEN FREE

| Ürün Kodu | | Ölçü(cm) | Açıklama | 📦 | Fiyat | |
|------------------|------------------|--------------|--------------------------------------|---|--------------------|--------------------|
| Opak Kapak | Şeffaf Kapak | | | | Opak Kapak | Şeffaf Kapak |
| 922.4050.201.032 | 922.4050.202.032 | 40 x 50 x 20 | 2 x 16 Sigorta + 1 Kompakt Şalter | 6 | 3.896,00 TL | 4.246,00 TL |
| 922.4060.201.048 | 922.4060.202.048 | 40x 60 x 20 | 3 x 16 Sigorta + 1 Kompakt Şalter | 6 | 4.374,00 TL | 5.152,00 TL |
| 922.5070.251.080 | 922.5070.252.080 | 50 x 70 x 25 | 4 x 20 Sigorta + 1 Kompakt Şalter | 4 | 6.095,00 TL | 6.970,00 TL |



922.4050.202.032



922.4060.201.048



922.5070.252.080

Monofaze Sayaçlı

IP65

HALOJEN FREE

| Ürün Kodu | | Ölçü(cm) | Açıklama | 📦 | Fiyat | |
|------------------|------------------|--------------|---------------------|----|--------------------|--------------------|
| Opak Kapak | Şeffaf Kapak | | | | Opak Kapak | Şeffaf Kapak |
| 930.2130.131.003 | 930.2130.132.003 | 21 x 30 x 13 | 1 Sayaç + 3 Sigorta | 20 | 1458,00 TL | 1560,00 TL |
| 930.2635.151.003 | 930.2635.152.003 | 26 x 35 x 15 | 1 Sayaç + 4 Sigorta | 12 | 1.710,00 TL | 1.860,00 TL |

Monofoze Sayaç+ Dağıtım

IP65

HALOJEN FREE

| Ürün Kodu | | Ölçü(cm) | Açıklama | 📦 | Fiyat | |
|------------------|------------------|--------------|----------------------|----|--------------------|--------------------|
| Opak Kapak | Şeffaf Kapak | | | | Opak Kapak | Şeffaf Kapak |
| 931.3040.131.013 | 931.3040.132.013 | 30 x 40 x 13 | 1 Sayaç + 13 Sigorta | 10 | 2.025,00 TL | 2.140,00 TL |
| 931.3040.171.013 | 931.3040.172.013 | 30 x 40 x 17 | 1 Sayaç + 13 Sigorta | 8 | 2.160,00 TL | 2.396,00 TL |
| 931.4050.201.224 | 931.4050.202.224 | 40 x 50 x 20 | 2 Sayaç + 24 Sigorta | 6 | 3.896,00 TL | 4.246,00 TL |



930.2635.151.003



931.4050.202.224

Trifaze Sayaçlı

IP65

HALOJEN FREE

| Ürün Kodu | | Ölçü(cm) | Açıklama | 📦 | Fiyat | |
|------------------|------------------|--------------|--|----|--------------------|--------------------|
| Opak Kapak | Şeffaf Kapak | | | | Opak Kapak | Şeffaf Kapak |
| 935.3040.131.010 | 935.3040.132.010 | 30 x 40 x 13 | 1 Sayaç + 10 Sigorta | 10 | 2.025,00 TL | 2.140,00 TL |
| 935.3040.171.010 | 935.3040.172.010 | 30 x 40 x 17 | 1 Sayaç + 10 Sigorta | 8 | 2.160,00 TL | 2.396,00 TL |
| 935.4050.201.014 | 935.4050.202.014 | 40 x 50 x 20 | 1 Sayaç + 14 Sigorta | 6 | 3.896,00 TL | 4.246,00 TL |
| 935.4060.201.008 | 935.4060.202.008 | 40 x 60 x 20 | 1 Sayaç + 8 Sigorta | 6 | 4.374,00 TL | 5.152,00 TL |
| 935.5070.251.010 | 935.5070.252.010 | 50 x 70 x 25 | 1 Sayaç + 10 Sigorta | 4 | 6.095,00 TL | 6.970,00 TL |
| 942.5070.251.000 | 942.5070.252.000 | 50 x 70 x 25 | Kompakt Şalter + Kaçak Akım + Akım Trafo | 4 | 6.095,00 TL | 6.970,00 TL |



935.4050.202.014



935.4060.201.008



935.5070.252.010



942.5070.251.000

Trifaze Sayaç + Dağıtım

IP65

HALOJEN FREE

| Ürün Kodu | | Ölçü(cm) | Açıklama |  | Fiyat | |
|------------------|------------------|--------------|----------------------|---|--------------------|--------------------|
| Opak Kapak | Şeffaf Kapak | | | | Opak Kapak | Şeffaf Kapak |
| 936.4050.201.024 | 936.4050.202.024 | 40 x 50 x 20 | 1 Sayaç + 24 Sigorta | 6 | 3.896,00 TL | 4.246,00 TL |
| 936.4060.201.040 | 936.4060.202.040 | 40 x 60 x 20 | 1 Sayaç + 40 Sigorta | 6 | 4.374,00 TL | 5.152,00 TL |
| 936.5070.251.068 | 936.5070.252.068 | 50 x 70 x 25 | 1 Sayaç + 68 Sigorta | 4 | 6.095,00 TL | 6.970,00 TL |



936.4050.202.024



936.4060.201.040



936.5070.252.068

Şantiye Panoları

IP65

HALOJEN FREE

| Ürün Kodu | | Ölçü(cm) | Açıklama |  | Fiyat | |
|------------------|------------------|--------------|--|---|--------------------|--------------------|
| Opak Kapak | Şeffaf Kapak | | | | Opak Kapak | Şeffaf Kapak |
| 965.4060.201.024 | 965.4060.202.024 | 40 x 60 x 20 | 1 Trifaze Sayaç + 24 Sigorta + 3 Priz Yeri | 6 | 4.374,00 TL | 5.152,00 TL |
| 965.5070.251.048 | 965.5070.252.048 | 50 x 70 x 25 | 1 Trifaze Sayaç + 48 Sigorta + 4 Priz Yeri | 4 | 6.095,00 TL | 6.970,00 TL |
| 965.5070.251.028 | 965.5070.252.028 | 50 x 70 x 25 | 1 Trifaze Sayaç + 28 Sigorta + 8 Priz Yeri | 4 | 6.095,00 TL | 6.970,00 TL |
| 966.4050.201.032 | 966.4050.202.032 | 40 x 50 x 20 | 32 Sigorta + 3 Priz Yeri | 6 | 3.896,00 TL | 4.246,00 TL |
| 966.4060.201.048 | 966.4060.202.048 | 40 x 60 x 20 | 48 Sigorta + 3 Priz Yeri | 6 | 4.374,00 TL | 5.152,00 TL |
| 966.4060.201.032 | 966.4060.202.032 | 40 x 60 x 20 | 32 Sigorta + 6 Priz Yeri | 6 | 4.374,00 TL | 5.152,00 TL |
| 966.5070.251.060 | 966.5070.252.060 | 50 x 70 x 25 | 60 Sigorta + 8 Priz Yeri | 4 | 6.095,00 TL | 6.970,00 TL |



966.4050.202.032



966.4060.201.032



965.4060.202.024



965.5070.251.028

Kofra Panoları

IP65

HALOJEN FREE

| Ürün Kodu | | Ölçü(cm) | 📦 | Fiyat | |
|------------------|------------------|--------------|----|--------------------|--------------------|
| Opak Kapak | Şeffaf Kapak | | | Opak Kapak | Şeffaf Kapak |
| 923.2635.151.000 | 923.2635.152.000 | 26 x 35 x 15 | 12 | 1.710,00 TL | 1.860,00 TL |
| 923.3040.171.000 | 923.3040.172.000 | 30 x 40 x 17 | 8 | 2.160,00 TL | 2.396,00 TL |
| 923.4050.201.000 | 923.4050.202.000 | 40 x 50 x 20 | 6 | 3.896,00 TL | 4.246,00 TL |



923.2635.151.000



923.3040.171.000



923.4050.202.000

Sulama Panoları

IP65

HALOJEN FREE

| Ürün Kodu | | Ölçü(cm) | Açıklama | 📦 | Fiyat | |
|------------------|------------------|--------------|---------------------------------|---|--------------------|--------------------|
| Opak Kapak | Şeffaf Kapak | | | | Opak Kapak | Şeffaf Kapak |
| 960.4050.201.000 | 960.4050.202.000 | 40 x 50 x 20 | Voltmetre + Ampermetre + Sinyal | 6 | 3.896,00 TL | 4.246,00 TL |
| 960.4060.201.000 | 960.4060.202.000 | 40x 60 x 20 | Voltmetre + Ampermetre + Sinyal | 6 | 4.374,00 TL | 5.152,00 TL |
| 960.5070.251.000 | 960.5070.252.000 | 50 x 70 x 25 | Voltmetre + Ampermetre + Sinyal | 4 | 6.095,00 TL | 6.970,00 TL |



960.4050.202.000



960.4060.201.000



960.5070.252.000

Pano Aksesuarları

| Ürün Kodu | Açıklama | 📦 | Fiyat |
|-------------|---|---|------------------|
| 740.020.000 | (40 x 50 - 40 x 60 - 50 x 70) Pano Ayak | 1 | 495,00 TL |
| 740.030.026 | 26 x 35 Pano Çatı | 1 | 200,00 TL |
| 740.030.030 | 30 x 40 Pano Çatı | 1 | 255,00 TL |
| 740.030.045 | (40 x 50 - 40 x 60) Pano Çatı | 1 | 275,00 TL |
| 740.030.050 | 50 x 70 Pano Çatı | 1 | 365,00 TL |

Küçük Boy Taşıyıcı Ayak

| Ürün Kodu | Açıklama | Ölçü (mm) |  | Fiyat |
|-------------|---|-----------|---|-------------|
| 740.022.001 | (351 - 451 - 352 - 452 - 361) Kombinasyonlar + (21x30 - 26x35 30x40) Panolar | 310x610 | 1 | 1.200,00 TL |



Büyük Boy Taşıyıcı Ayak

| Ürün Kodu | Açıklama | Ölçü (mm) |  | Fiyat |
|-------------|-----------------------------------|-----------|---|-------------|
| 740.022.002 | (40x50 - 40x60 - 50x70) Panolar | 510x1010 | 1 | 1.500,00 TL |



**M150 Plastik Gövdeli
Kablosuz Makaralar**

Ürün Kodu

Açıklama



Fiyat



150.000.04

4(1x16A) Şebeke

10

1.100,00 TL



150.000.04.T

4(1x16A) Şebeke + Termikli

10

1.300,00 TL

**M100 Metal Gövdeli Kablosuz
Makaralar - Sinyal Ledli**

Ürün Kodu

Açıklama



Fiyat



100.000.004

4(1x16A) Şebeke

10

1.915,00 TL



100.000.004.T

4(1x16A) Şebeke + Termikli

10





2.115,00 TL

| Makara Cinsi | Kablo Kesiti | 3x1,5 TTR | 3x2,5 TTR | 3x4 TTR | 4x1,5 TTR | 4x2,5 TTR | 4x4 TTR | 5x1,5 TTR | 5x2,5 TTR | 5x4 TTR |
|--------------|--------------|-----------|-----------|---------|-----------|-----------|---------|-----------|-----------|---------|
| M100 | | 50 | 40 | 30 | - | - | - | - | - | - |
| M120 | | 100 | 75 | 60 | 80 | 65 | 45 | 75 | 50 | 40 |
| M150 | | 60 | 50 | 40 | - | - | - | - | - | - |

M120 Kablosuz Makaralar

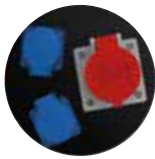
M120 Metal Gövdeli

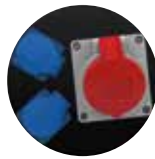
| Ürün Kodu | 12X.000.004 | 12X.000.004.T | 12X.000.004E | 12X.316.012 | 12X.416.012 |
|-------------------------|---|---|--|---|---|
| Makara Göbekleri |  |  |  |  |  |
| Açıklama | 4(1x16A) Şebeke + Sinyal | 4(1x16A) Şebeke + Sinyal + Termikli | 4(1x16A) Pano Prizi + Sinyal | 1(3x16A) CEE + 2(1x16A) Pano Prizi | 1(4x16A) CEE + 2(1x16A) Pano Prizi |
| Makara Fiyat | 2.414,00 TL | 2.535,00 TL | 2.607,00 TL | 2.674,00 TL | 2.738,00 TL |
| Tekerlekli Makara Fiyat | 3.550,00 TL | 3.671,00 TL | 2.600,00 TL | 3.668,00 TL | 3.732,00 TL |
| Arabalı Makara Fiyat | 3.905,00 TL | 4.026,00 TL | 3.956,00 TL | 4.023,00 TL | 4.087,00 TL |

| Ürün Kodu | 12X.516.012 | 12X.425.012 | 12X.332.012 | 12X.432.012 | 12X.532.012 |
|-------------------------|--|--|---|--|--|
| Makara Göbekleri |  |  |  |  |  |
| Açıklama | 1(5x16A) CEE + 2(1x16A) Pano Prizi | 1(4x25A) CEE + 2(1x16A) Pano Prizi | 1(3x32A) CEE + 2(1x16A) Pano Prizi | 1(4x32A) CEE + 2(1x16A) Pano Prizi | 1(5x32A) CEE + 2(1x16A) Pano Prizi |
| Makara Fiyat | 2.823,00 TL | 2.562,00 TL | 2.823,00 TL | 2.887,00 TL | 2.922,00 TL |
| Tekerlekli Makara Fiyat | 3.817,00 TL | 3.556,00 TL | 3.817,00 TL | 3.881,00 TL | 3.916,00 TL |
| Arabalı Makara Fiyat | 4.172,00 TL | 3.911,00 TL | 4.172,00 TL | 4.236,00 TL | 4.260,00 TL |

| Makara Cinsi | Kablo Kesiti | 3x1,5 TTR | 3x2,5 TTR | 3x4 TTR | 4x1,5 TTR | 4x2,5 TTR | 4x4 TTR | 5x1,5 TTR | 5x2,5 TTR | 5x4 TTR |
|--------------|--------------|-----------|-----------|---------|-----------|-----------|---------|-----------|-----------|---------|
| M120 | | 100 | 75 | 60 | 80 | 65 | 45 | 75 | 50 | 40 |

X = 0 Borulu Makara X = 1 Arabalı Makara X = 2 Tekerlekli Makara



120.000.004.T







122.416.012





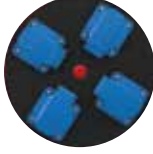

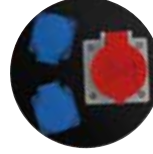
121.425.012

M130 Kablosuz Makaralar

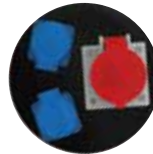
M130 Metal Gövdeli

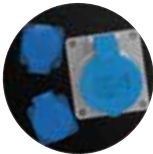
| Ürün Kodu | 13X.000.004 | 13X.416.012 | 13X.416.021 | 13X.516.012 | 13X.516.021 |
|-------------------------|---|---|--|---|---|
| Makara Göbekleri |  |  |  |  |  |
| Açıklama | 4(1x16A) Pano Prizi + Sinyal | 1(4x16A) CEE + 2(1x16A) Pano Prizi | 2(4x16A) CEE + 1(1x16A) Pano Prizi | 1(5x16A) CEE + 2(1x16A) Pano Prizi | 2(5x16A) CEE + 1(1x16A) Pano Prizi |
| Makara Fiyat | 3.460,00 TL | 3.590,00 TL | 3.840,00 TL | 3.675,00 TL | 4.010,00 TL |
| Tekerlekli Makara Fiyat | 4.439,00 TL | 4.570,00 TL | 4.820,00 TL | 4.656,00 TL | 5.416,00 TL |
| Arabalı Makara Fiyat | 4.794,00 TL | 4.925,00 TL | 5.175,00 TL | 5.010,00 TL | 5.345,00 TL |

| Ürün Kodu | 13X.425.012 | 13X.425.021 | 13X.332.012 | 13X.432.012 | 13X.532.012 |
|-------------------------|--|--|---|--|--|
| Makara Göbekleri |  |  |  |  |  |
| Açıklama | 1(4x25A) CEE + 2(1x16A) Pano Prizi | 2(4x25A) CEE + 1(1x16A) Pano Prizi | 1(3x32A) CEE + 2(1x16A) Pano Prizi | 1(4x32A) CEE + 2(1x16A) Pano Prizi | 1(5x32A) CEE + 2(1x16A) Pano Prizi |
| Makara Fiyat | 3.414,00 TL | 3.488,00 TL | 3.675,00 TL | 3.739,00 TL | 3.774,00 TL |
| Tekerlekli Makara Fiyat | 4.394,00 TL | 4.467,00 TL | 4.655,00 TL | 4.719,00 TL | 4.754,00 TL |
| Arabalı Makara Fiyat | 4.749,00 TL | 4.822,00 TL | 5.010,00 TL | 5.074,00 TL | 5.110,00 TL |

| Makara Cinsi | Kablo Kesiti | 3x1,5 TTR | 3x2,5 TTR | 3x4 TTR | 4x1,5 TTR | 4x2,5 TTR | 4x4 TTR | 5x1,5 TTR | 5x2,5 TTR | 5x4 TTR |
|--------------|--------------|-----------|-----------|---------|-----------|-----------|---------|-----------|-----------|---------|
| M130 | | 120 | 100 | 75 | 100 | 80 | 55 | 100 | 70 | 50 |

X = 0 Borulu Makara X = 1 Arabalı Makara X = 2 Tekerlekli Makara



130.516.012







132.532.012



131.516.021

M140 Kablosuz Makaralar

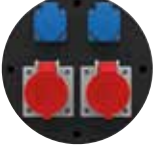
M140 Metal Gövdeli

| Ürün Kodu | 14X.416.022 | 14X.516.022 | 14X.425.022 | 14X.432.022 | 14X.532.022 |
|-------------------------|---|---|--|---|---|
| Makara Göbekleri |  |  |  |  |  |
| Açıklama | 2(4x16A) CEE + 2(1x16A) Pano Prizi | 2(5x16A) CEE + 2(1x16A) Pano Prizi | 2(4x25A) CEE + 2(1x16A) Pano Prizi | 2(4x32A) CEE + 2(1x16A) Pano Prizi | 2(5x32A) CEE + 2(1x16A) Pano Prizi |
| Makara Fiyat | 4.527,00 TL | 4.698,00 TL | 4.175,00 TL | 4.825,00 TL | 4.896,00 TL |
| Tekerlekli Makara Fiyat | 5.450,00 TL | 5.620,00 TL | 5.098,00 TL | 5.748,00 TL | 5.820,00 TL |
| Arabalı Makara Fiyat | 5.805,00 TL | 5.975,00 TL | 5.453,00 TL | 6.103,00 TL | 6.174,00 TL |

| Makara Cinsi | Kablo Kesiti | 3x1,5 TTR | 3x2,5 TTR | 3x4 TTR | 4x1,5 TTR | 4x2,5 TTR | 4x4 TTR | 5x1,5 TTR | 5x2,5 TTR | 5x4 TTR |
|--------------|--------------|-----------|-----------|---------|-----------|-----------|---------|-----------|-----------|---------|
| M100 | | 50 | 40 | 30 | - | - | - | - | - | - |
| M120 | | 100 | 75 | 60 | 80 | 65 | 45 | 75 | 50 | 40 |
| M130 | | 120 | 100 | 75 | 100 | 80 | 55 | 100 | 70 | 50 |
| M140 | | 180 | 140 | 125 | 170 | 130 | 100 | 135 | 110 | 90 |
| M150 | | 60 | 50 | 40 | - | - | - | - | - | - |
| M160 | | 60 | 50 | 40 | 50 | 35 | 25 | - | - | - |

X = 0 Borulu Makara X = 1 Arabalı Makara X = 2 Tekerlekli Makara



140.432.022



142.516.022



141.532.022



TEM

Acil Aydınlatma

Sabit ve seyyar olarak kullanılabilen ürünümüz, elektrik kesintisinde otomatik devreye girer ve fabrikalar, otoparklar, uzun koridorlar gibi geniş kullanım alanına sahiptir.



200.127.100
IP40 Çift Spotlu
4.300,00 TL





200.127.200
IP65 Çift Spotlu
5.000,00 TL



| | Çalışma Voltajı | Lamba | Renk Sıcaklığı | Şarj Süresi (Saat) | Çalışma Sıcaklığı | Koruma Sınıfı | Elektrik Sınıfı | Batarya Kapasitesi | Çalışma Süresi(dk) | Ürün Boyutları |
|-------------|-------------------------|----------|----------------|--------------------|-------------------|---------------|-----------------|------------------------------|--------------------|----------------|
| 200.127.100 | 110/220V AC 50-60Hz | 2x27 Led | 6000 - 6500 K | 48 | -10°C +40°C | IP 40 | II | 3.6V 2.5Ah LifePO4 | 180 | 270x82x290 |
| 200.127.200 | 85/65 V AC 50 / 60Hz | 2x24 Led | 6000 - 6500 K | 24 | -10°C +45°C | IP 65 | II | 3.7V 2.6Ah Lityum Batarya | 180 | 190x61x235 |

Seyyar Lamba - Baladoz

| Anahtarsız | Ürün Kodu | Açıklama |  | Fiyat |
|---|-------------|--------------|---|--------------------|
|  | 785.000.010 | Kablosuz | 10 | 460,00 TL |
| | 785.105.010 | 5m. Kablolu | 5 | 960,00 TL |
| | 785.110.010 | 10m. Kablolu | 5 | 1.330,00 TL |
| | 785.115.010 | 15m. Kablolu | 5 | 1.690,00 TL |
| | 785.120.010 | 20m. Kablolu | 4 | 2.090,00 TL |
| | 785.125.010 | 25m. Kablolu | 4 | 2.490,00 TL |

| Anahtarlı | Ürün Kodu | Açıklama |  | Fiyat |
|---|-------------|--------------|---|--------------------|
|  | 785.000.020 | Kablosuz | 10 | 528,00 TL |
| | 785.105.020 | 5m. Kablolu | 5 | 1.020,00 TL |
| | 785.110.020 | 10m. Kablolu | 5 | 1.392,00 TL |
| | 785.115.020 | 15m. Kablolu | 5 | 1.751,00 TL |
| | 785.120.020 | 20m. Kablolu | 4 | 2.151,00 TL |
| | 785.125.020 | 25m. Kablolu | 4 | 2.553,00 TL |

Seyyar Lamba - Çanaklı Baladoz

| Anahtarlı | Ürün Kodu | Açıklama |  | Fiyat |
|---|-------------|---------------|---|--------------------|
|  | 786.000.010 | Kablosuz | 10 | 1.945,00 TL |
| | 786.107.010 | 7.5m. Kablolu | 5 | 2.744,00 TL |

| Anahtarsız | Ürün Kodu | Açıklama |  | Fiyat |
|---|-------------|---------------|---|--------------------|
|  | 786.000.020 | Kablosuz | 10 | 1.842,00 TL |
| | 786.107.020 | 7.5m. Kablolu | 5 | 2.642,00 TL |

Kablolar



725.315.113
Çift Topraklı Fişli Kablo
3G 1,5 H0VV-F 3m.



725.325.113
Çift Topraklı Fişli Kablo
3G 2,5 H0VV-F 3m.



725.310.212
Güç Kablosu
3G 1 H0VV-F 1,8m.



725.315.123
İngiliz Fişli Kablo
3G 1,5 H0VV-F 3m.

Kablolar için fiyat sorunuz.

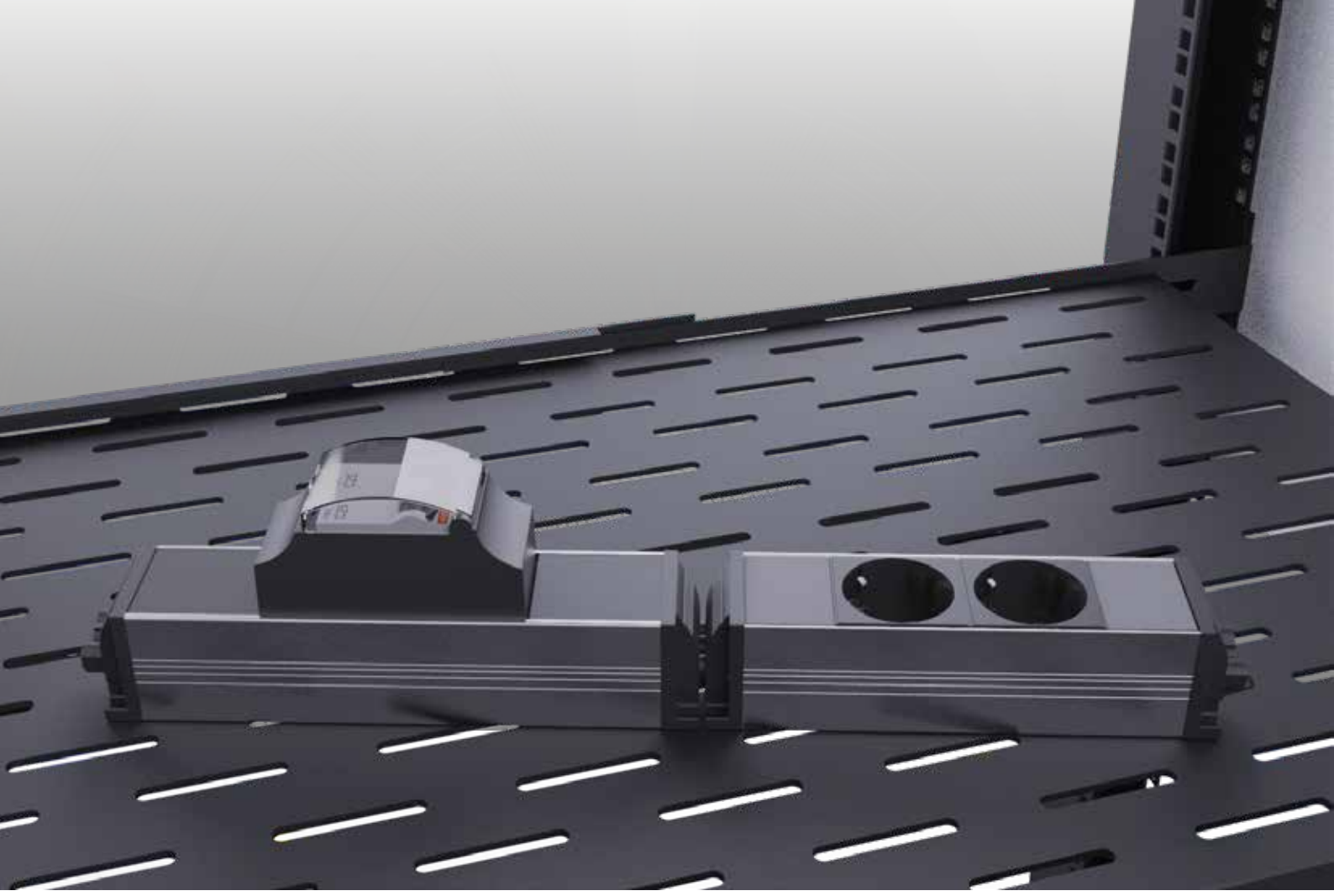

TEM®

TEM TEKNİK ELEKTRİK MALZEMELERİ SANAYİ VE TİCARET ANONİM ŞİRKETİ

 Selimpaşa Ortaköy Sanayi Bölgesi, İltar Bulvarı, Mor Menekşe Sok, No:5 34590
SİLİVRİ / İSTANBUL / TÜRKİYE

 +90 212 485 19 00

 +90 212 485 15 33

 www.temteknik.com

 info@temteknik.com



İskan ERDOĞMUŞ
Satış Koordinatörü

Marmara Bölgesi, Karadeniz Bölgesi,
Ege Bölgesi, Akdeniz Bölgesi, İç Anadolu
Bölgesi, Doğu - Güneydoğu Anadolu Bölgesi

iskanerdogmus@temteknik.com
0532 417 31 86